

This Instrument  
Prepared By:



407 E. Laurel Avenue  
Foley, AL 36535

# City of Foley, AL

## Signature Copy

Ordinance: 24-2021-ORD

File Number: 24-0327

Enactment Number: 24-2021-ORD

### AN ORDINANCE AMENDING THE CITY OF FOLEY ZONING ORDINANCE

WHEREAS, the City of Foley, Alabama, adopted Ordinance No. 387-87 on June 15, 1987, ordaining a new Zoning Ordinance and Zoning Map for the City of Foley which has subsequently been amended, and

WHEREAS, the City of Foley Planning Commission has recommended changes within the current Zoning Ordinance, and the City Council of the City of Foley deems it necessary, for the purpose of promoting the health, safety, morals and general welfare of the City to amend said Ordinance, and

WHEREAS, all requirements to the laws of the State of Alabama, with regard to the preparation of the report of the Foley Planning Commission and subsequent action of the City Council have been met,

NOW, THEREFORE, BE IT ORDAINED BY THE CITY COUNCIL OF THE CITY OF FOLEY, ALABAMA while in regular session accepted the changes as reflected in the attached documents that is to become a permanent part of this ordinance.

PASSED, APPROVED AND ADOPTED this 1st day of July 2024.



President's Signature *JW Travel*

Date 7-1-24

Attest by City Clerk *Kathryn Taylor*

Date 7-1-24

Mayor Signature *[Signature]*

Date 7/1/24

ORDINANCE 24- 2021-ORD

AMENDING THE CITY OF FOLEY ZONING ORDINANCE

WHEREAS, the City of Foley, Alabama, adopted Ordinance No. 387-87 on June 15, 1987, ordaining a new Zoning Ordinance and Zoning Map for the City of Foley which has subsequently been amended, and

WHEREAS, the City of Foley Planning Commission has recommended changes within the current Zoning Ordinance, and the City Council of the City of Foley deems it necessary, for the purpose of promoting the health, safety, morals and general welfare of the City to amend said Ordinance, and

WHEREAS, all requirements to the laws of the State of Alabama, with regard to the preparation of the report of the Foley Planning Commission and subsequent action of the City Council have been met,

NOW, THEREFORE, BE IT ORDAINED BY THE CITY COUNCIL OF THE CITY OF FOLEY, ALABAMA while in regular session accepted the following changes:

Zoning Ordinance Amendments:

**ARTICLE II - DEFINITIONS**

**2.1 DEFINITIONS APPLICABLE TO THIS ORDINANCE**

Dumpster Enclosure. Dumpster / Trash enclosures are a structure built to provide shelter for a trash dumpster and for recyclable materials.

Landscaping Material. Living material including, but not limited to, trees, shrubs, vines, lawn grass, ground cover, and landscape water features. Non-living material may be used in such a manner as to present a finished appearance and to complete coverage, and may consist of pine or cypress bark, crushed pecan shell, pine straw, or other decorative mulch.

Master Signage Plan (MSP): A comprehensive document presented to and approved by the Planning Commission that contains a set of criteria and standards for present and future freestanding signage in common areas of a Planned Development in order to create a cohesive architectural statement. The MSP should identify locations of all expected signage and call out any requested relaxations of the standard sign regulations included in this zoning ordinance. The MSP may be modified as needed during site plan approvals through a Planned Development's progress in phases.



Nit: A term used to describe a unit of measure for luminance intensity per unit area that is projected in a given direction. A nit is equal to one candela per square meter. A nit measures the luminance of a light source which is closely related to the perceived "brightness" of the light source.

Open Space: Land which is landscaped or left in a natural state and is intended for natural or scenic preservation and/or active / passive recreational uses and their accessory Structures. Where minimum Open Space reservation percentages of a development are required per the Zoning Ordinance, the percentage amount and use restrictions are detailed in the individual zone. The City's Land Development Ordinance also contains "Conservation Area" or "Green Space" requirements that must be met in conjunction with the Zoning Ordinance Open Space requirements.

Parking Space: The space necessary to park an automobile ~~which shall not be less than an area ten (10) feet wide by twenty (20) feet long for perpendicular parking spaces and nine (9) feet by twenty (20) feet for a herringbone/angle design.~~ All parking spaces required shall be provided along with necessary lanes and maneuvering areas. Size requirements are defined in Article 10. ~~No two-way entrance or aisle shall be less than twenty-five (25) feet in width. In no event shall an entrance or aisle be less than twenty (20) feet.~~

Planned Developments: Planned Developments include ~~Townhomes, Multi-Family and Mixed Use developments~~ R3 Residential Multi-Family, TH-1 Residential Townhouse, PUD Planned Unit Development, PDD Planned Development District, MH-1 Mobile/Manufactured Dwelling Parks, RV Recreational Vehicle Parks and PID Planning Industrial Districts.. These zones require a master plan layout prior to zoning / rezoning. The approved layouts then become the "zoning" for these properties and are considered site plan approval as well unless otherwise noted in the meeting minutes. The approved layouts can only be modified by the Planning Commission and in certain instances will require City Council approval as well.

Sign, Changeable Copy: A sign upon which the copy may be manually changed, rearranged, or altered or removed without altering the structure of the sign face or support.

Site Plan: The plan drawings of a proposed development on a lot or lots which reflects the existing conditions and proposed changes, including drainage, and any other possible environmental impact.

Sign, Monument: A sign mounted to the ground and designed with a continuous structural element of approximately the same dimension from the ground to the top of the sign.

Storage Structures / ~~Open Space-Storage~~: A structure, groups of structures or open space intended, designed, or capable of being used as rental storage facilities to individuals, businesses or other entities. Said definition shall also include the term "mini-warehouse", "boat", "RV" and other similar storage facility-facilities.

## **ARTICLE III - PURPOSE AND METHOD**

### **3.3 ZONING DISTRICT Classification Chart**

Designation	General Use	Specific Use
R-1R	Residential Zone	Restricted Single Family
R-1A	Residential Zone	Single Family
R-1B	Residential Zone	Single Family
R-1C	Residential Zone	Single Family
R-1D	Residential Zone	Single Family
R-2	Residential Zone	Single Family & Two Family
R-3	Residential Zone	Multi-Family
R-4	Residential Zone	Single Family & Two Family
GPH-1	Residential Zone	Garden-Patio Homes
TH-1	Residential Zone	Townhouses
MH-1	Residential Zone	Mobile Home/Park Subdivision
RV	Special Use	RV Park - short term rentals
PUD	Special Use	Planned Unit Development
PDD	Special Use	Planned Development District
PID	Industrial Use	Planned Industrial District
B-1	Commercial Use	Central Business District
B-1A	Commercial Use	Extended Business District
B-2	Commercial Use	Neighborhood Business District

Designation	General Use	Specific Use
B-3	Commercial Use	Local Business District
PO	Office Zone	Preferred Office District
M-1	Industrial Zone	Light Industry
A-O	Agriculture	Open Space / Agricultural Use
OSP	Parks/Public Land	Open Space / Preservation District
PUBLIC USE	Government/Public Use	Parks and Buildings for Public Use
H	Historic Overlay	Overlying Area of Historic District
FDOD	Foley Downtown	Overlay of Downtown

## ARTICLE IX - COMMERCIAL – MISCELLANEOUS

Dumpster / Trash Enclosures are considered accessory structures for setback, location and similar purposes. Please refer to Engineering / Public Works for specific design criteria.

## ARTICLE XIII - DISTRICT REGULATIONS

### 13.1.1 USES / STRUCTURES PERMITTED

Unless specifically prohibited in a particular zoning district, the following uses and structures are permitted by right in all districts.

A. ~~Public utilities, excluding electric and gas substations and water / wastewater pumping stations;~~

## ARTICLE X - PARKING, LANDSCAPING, BUFFER, & LIGHTING REQUIREMENTS

10.1.D.7. Warehouses, Storage Structures / Open Space Storage – 1 space for each 3,000 sq. ft. of gross floor area.

10.1.E Parking space and aisle size requirements:



1. Perpendicular spaces - 10 ft wide by 20 ft long
2. Herringbone/Angle spaces - 9 ft wide by 20 ft long
3. One way traffic parking lot aisle width - 20 ft minimum
4. Two way traffic parking lot aisle width - 25 ft minimum

#### **10.1.1.USE AND MAINTENANCE OF PARKING LOTS (NON-RESIDENTIAL)**

Off-street parking for non-residential uses:

- A. Required parking must be designated by pavement, gravel, cross-ties or some similar method.
- B. Shall not be used for the parking or storage of automobile trailers, boat trailers, non-motorized recreational vehicles and similar vehicles.

#### **10.3 Exterior Lighting Requirements**

- A. Purpose and Intent: The purpose of this regulation is to minimize light pollution, glare, and light trespass by establishing guidelines for exterior lighting applications. These regulations aim to ensure that outdoor lighting enhances safety and visibility while minimizing adverse impacts on the night sky and neighboring properties.
- B. Application Requirements:
  1. Exterior lighting plans are required for all projects other than single family residential. An exterior lighting plan, including a photometric plan (which covers the parcel which is the site of the building or project in question), appropriate pole, fixture, and lamp cut sheets, and descriptions of lenses and appropriate data tables, shall be submitted for review during the site plan approval process.
  2. All applications for exterior lighting installations must include the following:
    - a. Photometric Plans: A detailed photometric plan covering the entire site must be submitted. The plan should demonstrate the distribution of light and ensure compliance with the requirements outlined in this regulation. Photometric plans must be prepared by a licensed professional engineer or lighting designer.
    - b. Fixture Specifications: Complete specifications for all lighting fixtures proposed for installation, including cut sheets, must be provided. This should include information on the fixture type, wattage, shielding, and any additional features designed to minimize light pollution, glare, or spill light.
    - c. Mounting Heights: Proposed mounting heights for lighting fixtures should be specified, ensuring that fixtures are positioned to minimize upward light and glare.
    - d. Control Measures: Applicants must outline any proposed control measures, such as timers, motion sensors, or dimmers, intended to minimize unnecessary or excessive lighting during non-operational hours.
- C. Photometric Performance Requirements:

1. Light Distribution: Lighting fixtures must be selected and positioned to achieve uniform light distribution across the site, with emphasis on minimizing upward light and spill light onto adjacent properties.
  2. Cutoff Fixtures: All lighting fixtures must be cutoff fixtures, designed to limit upward light emissions and glare.
  3. Spill Light Control: Measures must be implemented to minimize spill light onto adjacent properties. This may include the use of shields, baffles, or other appropriate methods to direct light downward and confine it within the boundaries of the property.
- D. Illumination Levels:
1. Maximum Intensity: The maximum illumination levels at the property line should not exceed 0.5 footcandles when adjacent to residential properties and 1.0 footcandles when adjacent to other uses. These levels should be maintained throughout the operational hours of the lighting system.
  2. Gradual Dimming: Lighting systems must incorporate gradual dimming controls to reduce illumination levels during non-operational hours, minimizing light pollution and unnecessary energy consumption.
- E. Prohibitions: The installation, retrofitting, or modification of wall pack lighting fixtures, as well as any similar fixtures attached to exterior walls and characterized by outward-facing design and emitting excessive glare and spill light, is strictly prohibited.
- F. Compliance and Enforcement:
1. Inspections: Compliance with this regulation will be verified through site inspections conducted by authorized personnel.
  2. Penalties: Non-compliance with the requirements of this regulation may result in penalties, including fines and the requirement to modify or remove non-compliant lighting installations.
- G. Exemptions: While the following are exempt from certain provisions of this regulation but must still adhere to the principles of minimizing light pollution, glare, and light trespass to the greatest extent possible.
1. Emergency lighting necessary for safety and security purposes is exempt from certain provisions of this regulation but must still adhere to the principles of minimizing light pollution, glare, and light trespass to the greatest extent possible.
  2. Exemptions from the provisions of this ordinance are permitted when federal or state laws, rules, and regulations take precedence over these provisions.
  3. Public schools.
  4. Recreational sporting venues owned by the City
- H. Applicability: This regulation applies to all new exterior lighting installations and modifications to existing installations within the City.
- I. Definitions:
1. Photometric Plans: Detailed diagrams illustrating the distribution and intensity of light across a site, typically prepared by a licensed professional engineer or lighting designer. These plans provide critical information for assessing the performance of exterior lighting installations and ensuring compliance with regulatory standards.



2. Footcandle (f.c.): A unit of illuminance measuring one lumen per square foot.
3. Control Measures: Strategies and mechanisms implemented to regulate the operation of lighting systems, including timers, motion sensors, dimmers, and other devices intended to minimize unnecessary or excessive lighting during non-operational hours.
4. Light Distribution: The manner in which light is spread or dispersed across a given area, aiming to achieve uniform illumination while minimizing glare, hot spots, and uneven lighting. Proper light distribution is essential for optimizing visibility and safety in outdoor environments.
5. Cutoff Fixtures: Outdoor lighting fixtures designed to limit the upward emission of light and control glare by utilizing shielding or other mechanisms to direct light downward. Cutoff fixtures help minimize light pollution and prevent unnecessary illumination of the night sky.
6. Spill Light Control: Measures implemented to minimize the unintended projection of light beyond the boundaries of a property, reducing light trespass onto adjacent properties and minimizing the adverse effects of glare and excessive illumination.
7. Maximum Intensity: The maximum allowable level of illumination at the property line, typically expressed in footcandles (fc). Maximum intensity standards help ensure that lighting installations do not produce excessive glare or spill light onto neighboring properties, contributing to a more visually comfortable and environmentally responsible outdoor lighting environment.
8. Gradual Dimming: A feature of lighting systems that allows for the gradual reduction of illumination levels during non-operational hours. Gradual dimming controls help minimize light pollution, conserve energy, and promote responsible outdoor lighting practices by adjusting lighting levels to match changing environmental conditions and usage patterns.
9. Emergency Lighting: Lighting systems designed to provide illumination during emergency situations, such as power outages or evacuations, to ensure the safety and security of occupants. While emergency lighting is exempt from certain provisions of exterior lighting regulations, it is still subject to requirements aimed at minimizing light pollution, glare, and light trespass.
10. Wall pack lighting fixtures are defined as outdoor lighting fixtures designed to be attached directly to exterior walls, characterized by their outward-facing design and tendency to emit excessive glare and spill light.

## **ARTICLE XI - SITE PLAN REVIEW**

Site plans may be required to be submitted to the Planning Commission for input in cases where the proposed development meets the following criteria. Please note that site plan criteria for planned developments falls under a different category - see Definition. The site plan approval will be valid for 12 months but will expire after this date if no ~~building~~ development / building permits have been obtained. The Planning Commission may extend the site plan approval if ~~it is determined there is an extenuating circumstance~~. engineering & environmental permits are in process or if a portion of the building permits



have been pulled for the project. A new site plan meeting the most current regulations may be submitted for Planning Commission review & consideration.

## **ARTICLE XIV - SINGLE FAMILY RESIDENTIAL & DUPLEX DISTRICTS**

### **14.1.1 R-1R RESTRICTED RESIDENTIAL SINGLE FAMILY**

D. Requirements:

Garage Setback (Front Loaded)	40'
-------------------------------	-----

### **14.1.2 R-1A RESIDENTIAL SINGLE FAMILY**

D. Requirements:

Garage Setback (Front Loaded)	40'
-------------------------------	-----

### **14.1.3 R-1B RESIDENTIAL SINGLE FAMILY**

D. Requirements:

Garage Setback (Front Loaded)	40'
-------------------------------	-----

### **14.1.4 R-1C RESIDENTIAL SINGLE FAMILY**

D. Requirements:

Garage Setback (Front Loaded)	40'
-------------------------------	-----

### **14.1.5 R-1D RESIDENTIAL SINGLE FAMILY**

D. Requirements:

Garage Setback (Front Loaded)	40'
-------------------------------	-----

### **14.1.6 R-2 RESIDENTIAL SINGLE FAMILY AND DUPLEX**

D. Requirements:

SINGLE FAMILY:

Garage Setback (Front Loaded)	40'
-------------------------------	-----

DUPLEX:

Minimum Lot Area (duplex)	11,500 square feet*
---------------------------	---------------------

Landscape Requirements (duplex)	10% of Minimum lot area
---------------------------------	-------------------------

Garage Setback (Front Loaded)	40'
-------------------------------	-----

DEFINITIONS:

- i. Architectural Details - Include but are not limited to: porch railings; column size, taper, base and molding; dormer windows; shutters; ~~transparency;~~ and similar.
- ii. Building Facade Recesses - Porches or patios
- iii. Landscaping - ~~An area of mixed vegetation along the primary facade facing the street. Landscaping can consist of trees and/or shrubs.~~ See Definition of "Landscaping Material".

**14.1.7 R-4 RESIDENTIAL SINGLE FAMILY AND DUPLEX**

D. Requirements:

SINGLE FAMILY:

Garage Setback (Front Loaded)	40'
-------------------------------	-----

DUPLEX:

Minimum Lot Area (duplex)	11,500 square feet*
Landscape Requirements (duplex)	10% of Minimum lot area
Garage Setback (Front Loaded)	40'

DEFINITIONS:

- iv. Architectural Details - Include but are not limited to: porch railings; column size, taper, base and molding; dormer windows; shutters; ~~transparency;~~ and similar.
- v. Building Facade Recesses - Porches or patios
- vi. Landscaping - ~~An area of mixed vegetation along the primary facade facing the street. Landscaping can consist of trees and/or shrubs.~~ See Definition for "Landscaping Material".

**14.1.8 GPH-1 RESIDENTIAL GARDEN PATIO HOMES**

D. Requirements:

Garage Setback (Front Loaded)	40'
-------------------------------	-----

**ARTICLE XVI - MANUFACTURED HOMES**

**16.1.3.C Required Open Space:**

1. Each mobile / manufactured dwellings park shall provide land for open space which may be used for recreational purposes, but which may not be used for parking or for accessory

structures. Such open space shall total at least fifteen percent (15%) of the gross land area of the park. This requirement does not apply to mobile / manufactured dwellings subdivisions.

2. Mobile / manufactured dwellings subdivisions greater than five (5) acres in total area shall include, at a minimum, open space equal to ten percent (10%) of the total area. Such open space may be used for recreational purposes, but may not be used for parking or accessory structures.
3. The City's Land Development Ordinance also contains guidance and requirements for Conservation Green Space that must be met in conjunction with this Zoning Ordinance Open Space requirement.

## **ARTICLE XVII - RECREATIONAL VEHICLE (RV) PARK**

### **17.1.3 GENERAL REQUIREMENTS**

**17.3.D** Minimum 25% open space excluding required stormwater / drainage. The minimum 25% shall be reserved collectively in contiguous units accessible to all the RV sites and maintained by the property owners. This open space is to be used for: accessory uses, parks, recreation facilities, sidewalks, clubhouse, pool, and similar. The City's Land Development Ordinance also contains guidance and requirements for Conservation Green Space that must be met in conjunction with this Zoning Ordinance Open Space requirement.

## **ARTICLE XVIII - COMMERCIAL / OFFICE DISTRICTS**

**18.1.1.B** - Uses / Structures Permitted on Appeal: Automobile filling stations, motels, automobile repair (minor and major), large dry cleaners and laundries, veterinary clinics / hospitals, manufacturing incidental to a retail business where articles are sold at retail on the premises, other uses not specifically restricted herein; storage structures / open space storage; home based businesses; and home occupations.

**18.1.2.B** - Uses / Structures Permitted on Appeal: Automobile repair (major); large dry cleaners and laundries, veterinary clinics/hospitals, manufacturing incidental to a retail business where articles are sold at retail on the premises, other uses not specifically restricted herein; storage structures / open space storage.

**18.1.3.B** - Uses / Structures Permitted on Appeal: Large dry cleaners and laundries; veterinary clinics and hospitals; automobile repair (major), manufacturing incidental to a retail business where articles are sold at retail on the premises, wholesale businesses, storage structures / open space storage.

**18.1.4.B** - Uses / Structures Permitted on Appeal: Veterinary clinics / hospitals; kennels; wholesale; storage structures / open space storage.

## **ARTICLE XXI - PLANNED DEVELOPMENTS**



### 21.1.1 R-3 Residential Multi-Family

- E.6.b - Include sufficient open spaces in the form of squares, greens and parks. A minimum of 25% of open space shall be provided in all multiple family developments. Stormwater retention areas are not included in this 25% open space requirement, unless it is properly designed and determined to be acceptable open space by the Planning Commission. The City's Land Development Ordinance also contains guidance and requirements for Conservation Green Space that must be met in conjunction with this Zoning Ordinance Open Space requirement.

### 21.1.2 TH-1 Residential Townhouse

- D. Requirements:

Minimum Area	1 acre
Minimum Lot Area	2,400 square feet*
Minimum Lot Width at Building Line	25 24 feet
Minimum Depth of Front Yard	20 feet
Minimum Depth of Rear Yard	15 feet
Minimum Width of Side Yard (on end unit)	16 feet
Minimum Depth of Side Yard Abutting Street	16 feet
Minimum Open Space if <5 ac	20%
Minimum Open Space if ≥5 ac	25%
Maximum Building Height (feet):	50 feet
Maximum Building Height (stories):	3
Off-Street Parking Spaces (per family unit)	2
Maximum Density Per Acre	15

\* or meet Health Department requirements.

- H.9 - Townhouse developments with a total area less than five (5) acres shall have at least twenty (20) percent common open space and five (5) acres or greater shall have at least twenty-five (25) percent of the total area devoted to common open space, exclusive of parking areas, accessory buildings, or required drainage. Such common open areas may include recreational facilities. In addition, the developer of a townhouse development or homeowners association created by the developer by recorded covenants and restrictions, shall preserve for the owners

and occupants of the development such lands set aside for open areas, parks, or recreational use, and the common off-street parking spaces established for the development. The City's Land Development Ordinance also contains guidance and requirements for Conservation Green Space that must be met in conjunction with this Zoning Ordinance Open Space requirement.

#### **21.2.1 PUD - PLANNED UNIT DEVELOPMENT**

- **C.7 - Open Space Reservation:** Not less than 25% of the PUD site shall be reserved collectively in contiguous units accessible to all the building sites in the PUD and maintained by the property owners for open space for the purpose of providing parks, recreational facilities, ways for pedestrian movement and circulation, and for conserving visually pleasing elements of the environment. This open space does not include areas reserved for drainage purposes. If the PUD is developed in stages, the amount of open space reserved and developed for use in each stage will constitute no less than an equivalent proportional amount to the area being developed. The City's Land Development Ordinance also contains guidance and requirements for Conservation Green Space that must be met in conjunction with this Zoning Ordinance Open Space requirement.

#### **21.5 PDD – PLANNED DEVELOPMENT DISTRICT**

G. There shall be a minimum of at least twenty percent of the gross lot area (20%) designated open space in a PDD exclusive of all drives, walkways, parking areas and required drainage. Access roads and drainage infrastructure, water, sewer, electricity, telephone and other utilities shall be provided to serve the development at the completion of construction of each development phase. Performance bonds may not be posted for drainage and sewer work. The City's Land Development Ordinance also contains guidance and requirements for Conservation Green Space that must be met in conjunction with this Zoning Ordinance Open Space requirement.

## **ARTICLE XXV - OVERLAY DISTRICTS**

### **25.2 FOLEY ZONING MAP**

A layer defining the Historic Overlay District boundary will be provided in the online Foley Zoning Map. ~~The Foley Zoning Map shall be amended and shall reflect the designation of the Historic District Overlay according to the Historic District Overlay Boundaries and the letter H added as a suffix to the underlying zoning district(s).~~

### **25.8 ESTABLISHMENT OF FDOD BOUNDARIES**

A map of the FDOD overlay boundary is included in the Zoning Ordinance (see Appendix Exhibit A), and a layer containing the FDOD boundary will be provided in the online Foley Zoning Map. ~~The Foley Zoning Map shall reflect the designation of the Foley Downtown Overlay District according to the Foley~~

~~Downtown Overlay District Boundaries and the letters FDOD added as a suffix to the underlying zoning district(s).~~

## Proposed Amendments to ZO - Signs

### ARTICLE XXII - SIGN REGULATIONS

22.1 GENERAL PROVISIONS

22.2 PROHIBITED SIGNS

22.3 TEMPORARY SIGNS NOT REQUIRING PERMITS

22.4 TEMPORARY SIGNS REQUIRING AN EXEMPT PERMIT

22.5 SIGNS REQUIRING A PERMIT

22.6 ELECTRONIC SIGN REGULATIONS

22.7 SIGNS LOCATED IN OVERLAY DISTRICTS

### ARTICLE XXII - SIGN REGULATIONS

The purpose of these sign regulations are: to encourage the effective use of signs as a means of communication; to maintain and enhance the aesthetic environment and the city's ability to attract sources of economic development and growth; to improve pedestrian and traffic safety; to minimize the possible adverse effect of signs on nearby public and private property; and to enable the fair and consistent enforcement of these sign restrictions. This sign ordinance is adopted under the zoning authority of the city in furtherance of the more general purposes set forth in the Zoning Ordinance.

#### **22.1 - GENERAL PROVISIONS**

- A. PERMITS REQUIRED - Except as otherwise provided in this Ordinance, it shall be unlawful for any person to erect, construct, enlarge, move, alter or convert any sign in the City or cause the same to be done, without first obtaining a Building Permit for each sign from the Building Official.
1. APPLICATION FOR PERMIT - The City's online application process shall be followed to request a sign permit. The following information is required to assure compliance with all appropriate laws and regulations of the City:
    - a. Name and address of owner of the sign.
    - b. Name and address of owner or the person in possession of the premises where the sign is located or to be located.
    - c. Clear and legible drawings with description definitely showing the location of the sign which is subject of the permit and all other existing signs for that particular business at that location. Signs located at intersections should also



provide required Vision Clearance Areas on the drawing as defined in section 22.1.D below.

- d. Drawings showing the dimensions, construction supports size, electrical wiring, components, illumination method, materials of the sign and method of support.
  - e. If the sign is or will be located within the Local Downtown Historic District, a Certificate of Appropriateness (COA) must be received prior to permit application.
2. DENIAL OF PERMIT - When a permit is denied by the Community Development Director, notice shall be given to the proper applicant with a written statement of the reason or reasons for the denial. Said statement shall be made as an attachment to the permit application.
  3. APPEAL OF PERMIT DENIAL - If the denial is based on the interpretation or enforcement of the Zoning Ordinance, any aggrieved party may appeal the decision or interpretation of the Community Development Director to the Zoning Board of Adjustment and Appeals.
  4. USES PERMITTED AND USES PERMITTED ON APPEAL - Signs allowed for Article XIII - District Regulations (Section 13.1.1 "Uses Permitted", and Section 13.1.2 - "Uses Permitted on Appeal") shall meet the requirements of the zoning district in which they are located.
  5. PERMIT EXCEPTIONS - The following activities shall not require a permit from the City of Foley, but the sign shall comply with the other provisions of this ordinance:
    - a. Altering the advertising copy or message on an existing approved sign or marquee which is specifically designed for the use of replacement copy.
    - b. Painting, cleaning or other normal maintenance and repair of a sign not involving structural changes.
- B. MAINTENANCE / UNSAFE SIGNS - Every sign in the City shall be maintained in good structural condition. The Community Development Director may inspect and shall have the authority to order the painting, repair, alteration or removal of signs which become dilapidated or abandoned or which constitute a physical hazard to public safety. Any repair, painting, alteration, or removal will be at the sign owner's expense.
- C. LOCATION
1. All signs shall be on premise and may not extend beyond the property lines of the property on which the sign is located nor interfere with any public right-of-way or public easement, except as permitted specifically within this Ordinance or other City ordinances.
  2. No signs shall be erected in public right-of-way or on public sidewalks, except those necessary for regulatory, statutory or traffic control purposes, or other directional signs placed by the City of Foley, Baldwin County, the State of Alabama, or the United States.
- D. VISIBILITY
1. No sign shall be located so as to cause a public hazard, obstruct or impair motorists' vision, diminish safe ingress and egress to any property or impede flow of pedestrian or vehicular circulation in parking areas, sidewalks, or public roads.

2. Signs may not be located within the vision clearance areas, the triangular shaped areas located at the intersection of any combination of streets, alleys or driveways (as defined below). Nothing may be erected, placed, planted or allowed to grow in such a manner as to limit or obstruct the sight distance of motorists entering or leaving the intersection. The sides of the triangle extend from the intersection of the pavement or other vehicle travel areas.

a. Required Vision Clearance Area distances

Visibility Requirement by Street Classification				
A Distance in Feet	Street Type	B Distance in Feet		
		Driveway	Local Street	Collector/Arterial
25	Driveway	25	30	100
30	Local Street	25	30	100
100	Collector/Arterial	25	30	100

b. Vision Clearance Areas

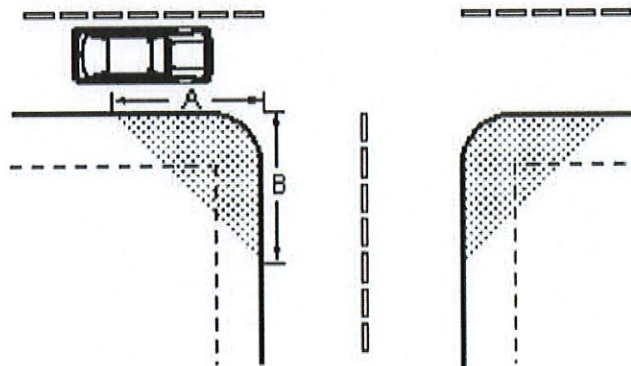

3. Signs must be located to provide unobstructed visibility and shall not be located between the heights of two and one-half (2 1/2) feet and ten (10) feet from grade within the Vision Clearance Areas. Structures and supports must have a combined total width of 12 inches or less and the combined total depth of 12 inches or less.

a. Vision Clearance Area

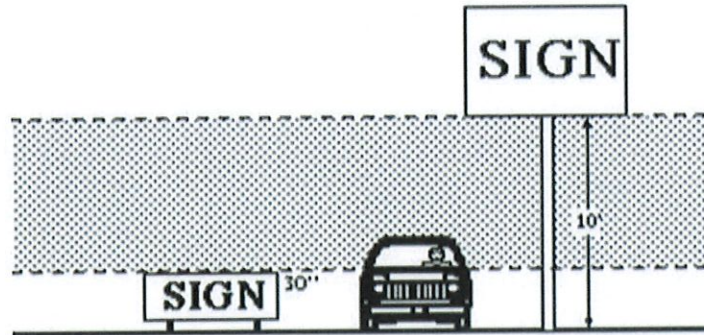

Height

E. MEASUREMENT AND CALCULATION STANDARDS

1. SIGN HEIGHT

- a. The height of a sign shall be computed as the distance from the base of the sign at normal grade (average grade at the base of the sign) to the top of the highest attached component of the sign.
- b. Normal grade shall be construed to be the newly established grade after construction, exclusive of any filling, berming, mounding, or excavating solely undertaken for the purpose of locating or increasing the height of sign.

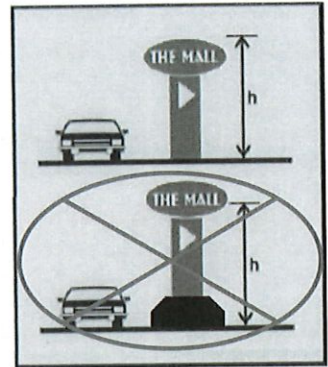

2. SIGN WIDTH

- a. The width of a sign shall be measured across the widest portion of a sign that runs parallel to the ground at the base of the sign.
- b. The sign width shall include all structure elements of a sign (e.g., support posts, sign cabinet, etc.).

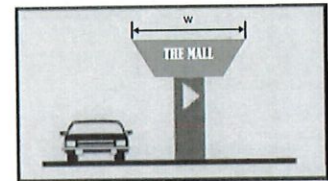

3. SIGN FACE AREA



- a. For sign copy mounted or painted on a background panel, cabinet, or surface distinctively painted, textured, lighted, or constructed to serve as the background for the sign copy, the sign area shall be computed by means of the smallest square, circle, rectangle, triangle, or combination thereof that
- e

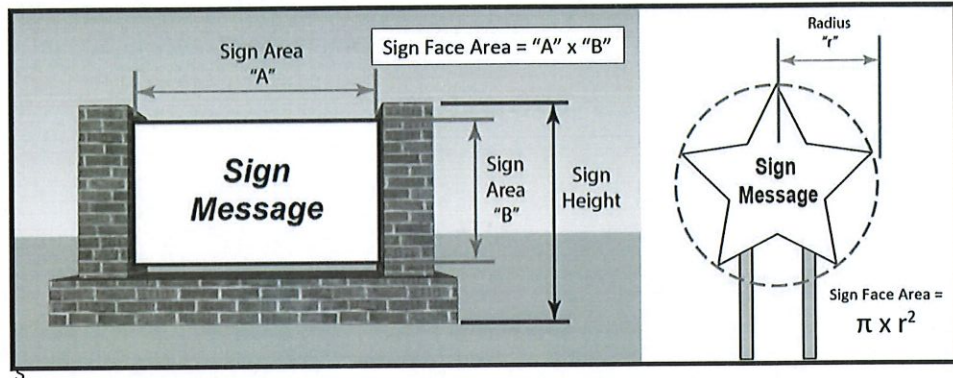

the extreme limits of the background panel, cabinet, or surface.

- b. For sign copy where individual letters or elements are mounted or painted on a building façade where there is no background panel, cabinet, or surface distinctively painted, textured, lighted, or constructed to serve as the background for the sign copy, the sign area shall be computed by means of the combination of the smallest square, circle, rectangle, triangle, or combination thereof that encloses all the letters or elements associated with the sign.

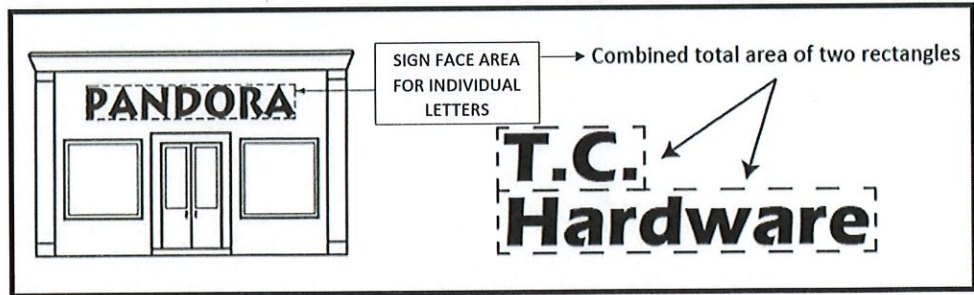

- c. The calculation of sign area shall not include any supporting framework, bracing, or decorative fence or wall unless such structural support is determined to constitute an integral part of the sign design by means of text or other commercial message, as determined by the Community Development Director.

#### F. SIGN TYPES

1. DETACHED SIGNS - Any sign supported by structures or supports that are placed on, or anchored in, the ground and that are independent from any building or other structure.
  - a. Monument Signs - A sign mounted to the ground and designed with a continuous structural element of approximately the same dimension from the ground to the top of the sign.

- b. Pole/Pylon Signs - Any sign supported by a pole, or poles, and otherwise separated from the ground by air.
- c. Multi-tenant Locator Signs - A single ground sign which identifies multiple businesses which are all tenants in a single structure, shopping center or complex. Must be located on the property that is being leased by the businesses who are displayed on the sign face unless otherwise allowed in this ordinance.
- d. Incidental/Directional Signs - A sign, generally informational, such as "no parking", "entrance", "exit", "loading only", "drive-through", "menu boards", and other similar directives. No sign with a commercial message legible from a position off the zoned lot on which the sign is located shall be considered incidental.

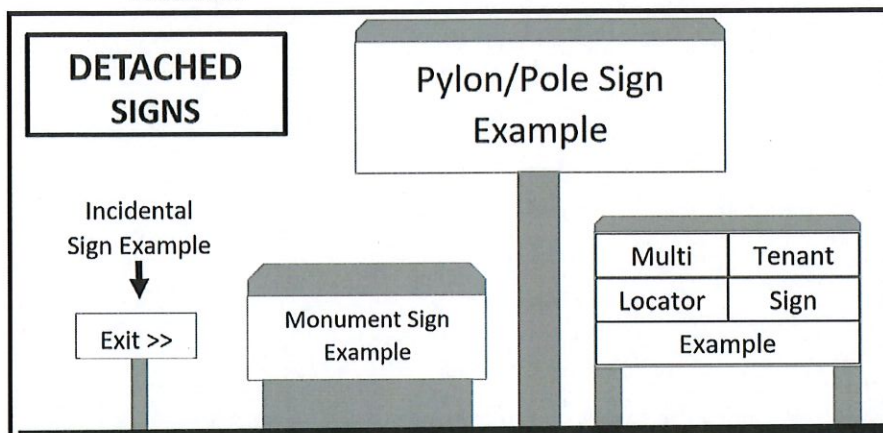

2. ATTACHED SIGNS

- a. Wall Signs - A sign entirely affixed directly to the wall of a building or the slope of a mansard-type roof, and/or projecting to a point less than twelve (12) inches beyond the wall surface.
- b. Suspended/Hanging Signs - A sign that is suspended from the underside of a horizontal plane surface and is supported by such a surface.
- c. Projecting Signs - Any sign affixed to any building or structure, extending beyond the building wall, structure, or building line by more than twelve (12) inches and no more than eighteen (18) inches. (For Local Downtown Historic District properties, refer to the Design Guidelines)
- d. Canopy/Awning Signs - Any sign that is a part of or attached to an awning, canopy, or other fabric, plastic, or structural protective cover over a door, entrance, window, or outdoor service area. A marquee is not a canopy.
- e. Marquee Signs - A projecting sign which is attached to or hung from a canopy, or a covered structure projecting from or supported by a building, extending beyond the building line.
- f. Mural Signs - A decoration or artwork painted on the exterior wall of a building which may be classified as a sign when it contains lettering, trade emblems or

logos. When such items are incorporated, the sign specifications shall be as follows:

1. Lettering- shall be localized and the area measured to conform to the size limitations of this Ordinance.
  2. Trade emblems and logos- the entire area of the mural shall be considered to be the sign face area and shall meet the size limitations contained in this Ordinance.
- g. Painted Wall Signs - A sign that is not a mural, but which is painted directly on the surface of a structure.
- h. Window Signs - Any sign, pictures, symbol, or combination thereof, designed to communicate information about an activity, business, commodity, event, sale or service, that is placed inside a window or upon the window panes or glass and is visible from the right-of-way.

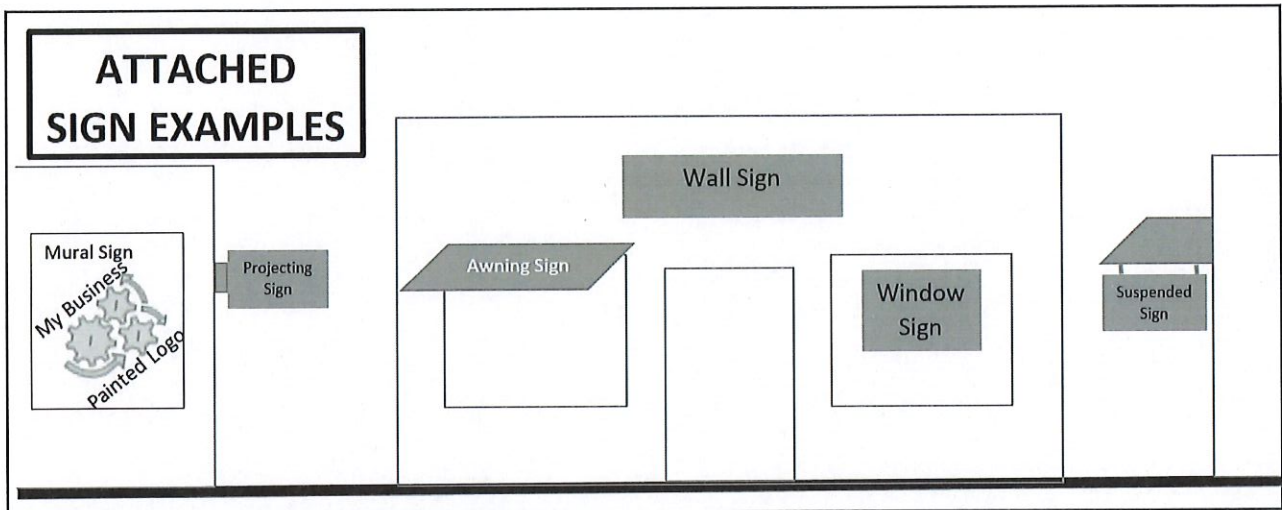

### 3. METHODS OF ILLUMINATION

- a. DIRECT - Light sources, including spotlights and neon tubing, which is attached to the sign face or structure and directed toward the copy area.
- b. INDIRECT - Light sources not attached to the sign structure or face area, but which are designed to be directed onto the sign face area.
- c. INTERNAL - Light sources enclosed in a sign face.
- d. ELECTRIC MESSAGE CENTER - Light sources arranged in rows, intended and designed to be individually and sequentially lit in such a manner to form letters and/or graphics which may blink on and off, travel, or flash. (See section 22.6 for further details and requirements.)



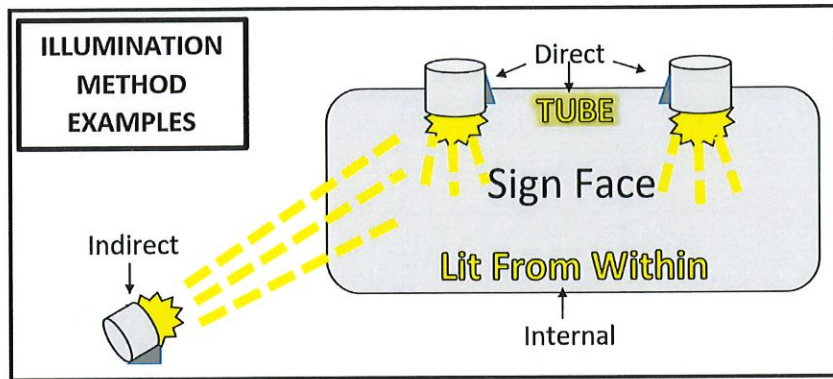

**G. NON-CONFORMING SIGNS**

1. SIGNS ELIGIBLE TO BE CONSIDERED "LEGAL NON-CONFORMING" - Any sign located within the city limits on the date of the adoption of this Ordinance or located in any area annexed to the City hereafter which does not conform to the provisions of this Ordinance, is eligible for characterization as a "Legal Non-Conforming" sign and is permitted, provided it meets the following requirements:
  - a. A permit had been issued for the construction of such sign prior to the date of the adoption of this Ordinance, if one was required under any other or prior city ordinance, or if no sign permit was required under any prior applicable City ordinances for the sign in question, the sign must have been in compliance with the prior applicable City ordinances as of the date of the adoption of this Ordinance.
  - b. If a sign was in compliance with all applicable regulations and laws prior to being annexed into the City of Foley, but is either prohibited or fails to conform with the Zoning Ordinance after annexation, then such sign may be considered a legal non-conforming sign.
2. LOSS OF LEGAL NON-CONFORMING STATUS - A legal non-conforming sign shall immediately lose its legal non-conforming status upon the occurrence of one or more of the events listed in this Zoning Ordinance, pursuant to state law, or when there is a change in:
  - a. The type of use or occupancy type on the property on which the sign is located;
  - b. The location, size, height, or type of sign; or
  - c. The amount of frontage such that the existing sign would not be permitted by this Ordinance.
  - d. A sign, being a structure, is also subject to the provisions of section 6.2.2 of this ordinance in regard to a prohibition of restoration after damage greater than 50% of its current replacement value.

**22.2 - PROHIBITED SIGNS**

The following signs are prohibited in the City of Foley, and no permits for the construction of these signs will be issued, and all existing signs of this nature that are now in the corporate limits of the City of Foley or may hereafter come into the corporate limits of the City of Foley will either be classified as legal non-conforming or unlawful.

- A. Billboards, provided, however, the Planning Commission may, as part of its approval of the Master Signage Plan (MSP) for a PUD, PDD, or PID, grant one or more lots in the development the option to locate their ground sign(s) in specifically defined locations in a common area of that same PUD, PDD, or PID.
- B. Signs located in public areas or right-of-ways. With the exception of: Signs erected by or on behalf of the governmental entity responsible for maintenance and repair of said right-of-way, including signs posting legal notices, identifying public property, conveying public information, and signs directing or regulating pedestrian or vehicular traffic to businesses or other locations; bus stop signs erected by a public transit company; informational signs of a public utility regarding its poles, lines, pipes, or facilities; and awnings, projecting and suspended signs which conform to the conditions of these regulations.
- C. Vehicle Signs: except those vehicles used in normal day-to-day operations of the business. Vehicles parked for more than three (3) consecutive days are not considered regularly used in the conduct of normal day-to-day business. Vehicle signs used in normal day-to-day business shall be parked to the rear or side of businesses when possible. When rear and side parking is not possible vehicles shall be parked at a minimum of 100 feet from all highways and expressways. No vehicle signs shall be parked in the City right-of-way, unless the business has no other parking areas on premise.
- D. Portable Signs: A moveable sign that is not permanently attached to either the ground or a structure, or a sign designed to be transported, including, but not limited to, signs designed to be transported by means of wheels; sign converted to A- or T- frames; menu and sandwich board signs; feather flags; ~~pennants~~; handheld signs; caricature signs; inflatable's; umbrellas (used for advertising), except those permitted as Special Event Signs in 22.4 EXEMPT PERMIT SIGNS or those which may be allowed in an applicable Overlay District.
- E. Roof top signs.
- F. Beacons and Revolving signs.
- G. Flashing signs, traveling lights or intensely lighted signs.

### **22.3 - TEMPORARY SIGNS NOT REQUIRING PERMITS**

The following temporary signs are allowed with the following conditions, and do not require a permit. This section specifically excludes Special Event Signs/Displays as described in 22.4 EXEMPT PERMIT SIGNS.

- A. Temporary signs shall not be illuminated.
- B. Drives or events of a civic, educational or religious nature are allowed to advertise for a period of two (2) weeks provided that:

1. The sign is non-electric.
  2. The sign face must be less than thirty-two (32) square feet.
  3. They may be located on and/or off premise, provided it is not in the public right-of-way nor causing a traffic hazard (see 22.1 D - Visibility).
- C. New businesses in the City are allowed to advertise with a single sign for a period of (2) weeks provided that:
1. The sign is non-electric.
  2. The sign face must not exceed thirty-two (32) square feet.
  3. The sign is located on premises and is not located in the public right-of-way nor causing a traffic hazard (see 22.1.D - Visibility).
- D. Real Estate Signs:
1. Real Estate "For Sale" or Rental Signs (Residential):
    - a. Two (2) signs per property advertising the sale or rental are allowed on-premise and two (2) signs are allowed off-premise.
    - b. Must not exceed four (4) square feet of copy area per sign.
    - c. Such signs shall not be permitted for a period longer than thirty (30) days after closing the sale or rental of the property.
  2. On-Premise Real Estate "For Sale" or "For Rent" Signs (Commercial):
    - a. One (1) real estate "For Sale" or "For Rent" sign for commercially zoned properties is allowed for properties with up to 500 linear feet of frontage. An additional sign is allowed for each additional 500 feet of frontage.
    - b. Must be located entirely within the property.
    - c. Must not exceed thirty-two (32) square feet of copy area per sign.
    - d. Such sign(s) shall be removed within thirty (30) days of closing the sale or rental of the property.
  3. Off-Premise Real Estate "For Sale" or "For Rent Signs (Commercial):
    - a. One (1) sign advertising the selling or rental of such property is permitted
    - b. Must not exceed four (4) square feet of copy area.
    - c. Such sign shall be removed within thirty (30) days of closing the sale or rental of the property.
  4. Construction Signs:
    - a. Must not exceed thirty-two (32) square feet of sign face.
    - b. May be placed no sooner than actual demolition or construction activities begin and may continue until the permanent sign is erected or the certificate of occupancy is issued, whichever comes sooner.
    - c. Such sign shall not be located in the public right-of-way nor cause a traffic hazard (see 22.1.D - Visibility).
  5. Model Homes:
    - a. Temporary A-frame signs shall be allowed in residential zones only to be located on the lot of the model home during the business hours in which an agent(s) is present.
- E. Campaign or Election Signs are exempt provided that:



1. Signs advocating or opposing a public office or a position on an issue to be determined at an election shall not exceed twelve (12) square feet in residential districts. In all other zoned districts, signs shall not exceed thirty-two (32) square feet.
2. Signs advocating or opposing a public office or position on an issue to be determined at an election shall be removed within ten (10) days after the election for which they were erected. In the event of a runoff election, signs may be displayed until the runoff election and then shall be removed within ten (10) days of the runoff election.
3. Property owners shall be held responsible for violations of campaign and election signs.
4. No signs shall be allowed in the public right-of-way, project into or overhang any right-of-way or be attached to any utility pole within the right-of-way.

F. Decorative Displays

1. Single balloons under twenty-four (24) inches in circumference that do not contain copy are considered decorative.
2. Flags that display seasonal, holiday, governmental and political displays are considered decorative.

**22.4 - TEMPORARY SIGNS REQUIRING AN EXEMPT PERMIT**

Temporary special use or event signs and displays are allowed but only under the following conditions and requirements:

- A. Special event signage and displays require an Exempt Permit (no fee required) found in the City's online permitting system under Planning & Zoning - Special Event Signs/Displays prior to the erection and placement of any such temporary sign or display. Such signs and displays shall be specifically described in writing as to their type and reason for special event.
  - a. Signs shall not exceed five (5) feet in height except for portable billboards.
  - b. Such signs shall not be illuminated.
  - c. For all lots containing multiple businesses, the property owner shall be responsible for all signage placed on the property, regardless of who erects the sign.
  - d. All such signs shall not be placed within ten (10) feet of the street right-of-way or in any other way as to obstruct the view of motorists or pedestrians.
  - e. An individual business shall be allowed a maximum of six (6) special event sign permits per calendar year, each of which shall be valid for four (4) consecutive days starting from the date of registration issuance or as noted on the registration.
- B. The following types of signs/displays which attract attention to a particular business may be registered as special event signs/displays:

SPECIAL EVENT SIGN / DISPLAY		
Sign Type	Quantity Allowed	Max Size Allowed

Balloons & Inflatables	1	20 ft in height from grade
Feather Flags	2	20 ft in height from grade
Pennants	2	???
Hand-held signs	1	6 sf sign face
Caricature signs	???	???
A or T frame signs	1	12 sf sign face
Menu/Sandwich Boards	1	12 sf sign face
Umbrellas	???	8 ft diameter
Banners	1	12-sf 30 sf sign face
Plastic/wire frame signs	1	12 sf sign face
Flags (not otherwise exempt)	1	15 sf
Portable Billboards	1	10'x13' or 130 sf

**22.5 - SIGNS REQUIRING A PERMIT**

A. PLANNED DISTRICT SIGNAGE - A Master Signage Plan (MSP) is designed to benefit the community in administering its sign regulations within a planned development and is required for the following zoning designations: Planned Unit Development (PUD), Planned Development District (PDD), and Planned Industrial District (PID). The Planning Commission will review the location, size, and other information to approve ground signs in common areas advertising specific businesses within a development. The Planning Commission may also review and approve any unique requests for other signage in these zones. The required information includes:

1. An accurate plot plan of the Development at a legible scale;
2. Location of signage for common areas, buildings, parking lots, driveways, amenities, landscaped areas and others;
3. An accurate indication of the proposed location of each present and future sign.
4. Size of the total Sign Face Area, the area of each individual sign, the height of the signs, an outline of the Sign Structure, and any electronic signage being requested.

5. A detailed description of any relaxation or exception that is being requested from the sizes shown in the following charts.
6. Documentation of who will be responsible for the maintenance and upkeep of the ground signs.

**B. RESIDENTIAL SIGNAGE**

1. The following Zones are considered “residential” for the purposes of these sign regulations: R-1R, R-1A, R-1B, R-1C, R-1D, R-2, R-3, R-4, GPH-1, TH-1, MH-1, RV Park, and residential areas of a PUD, PDD, or AO

RESIDENTIAL SIGNAGE ALLOWED								
Purpose	Sign Type	Max Area per Face	# Faces	Max Height	Illumination	Setback	Number Signs	Electronic allowed?
Primary Entrance Neighborhood Identification	Ground	50 sf	2	6 ft	Direct or Indirect		1 at Main entrance	no
Secondary Entrance Neighborhood Identification	Ground	32 sf	2	5-4 ft	Direct or Indirect	25-ft	1 per Secondary entrance	no
Home Occupation	Ground	4 sf	2	4 ft	PROHIBITED		1	no
Bed & Breakfast	Ground	4 sf	2	4 ft	Direct or Indirect		1 containing only name, street address, and occupancy info	no

**C. COMMERCIAL/INDUSTRIAL SIGNAGE**

1. The following Zones are considered “commercial/industrial use” for the purposes of these sign regulations: B-1, B-1A, B-2, B-3, M-1, Commercial & Industrial areas of a PUD or PDD
2. Painted Murals on the sides of buildings are allowed and are not considered to be a sign unless copy is included which advertises a business or service. If copy is included, this is a sign and must comply with this ordinance.
3. If a business does not have a ground sign, the wall sign may be increased by the square footage of the allowed ground sign.



4. Signs for free standing single tenant retail establishments in excess of 100,001 sf may increase by 10% for each additional 100,000 sf.
5. Based on street frontage, the total sign face area (wall & ground) as determined by following Commercial charts below may be increased as follows:

SIGN FACE AREA BY STREET FRONTAGE					
FRONTAGE	200-400 ft	401-600 ft	601-800 ft	801-1000 ft	>1000 ft
Increase to Sign Face Area	10%	20%	30%	40%	50%

6. The square footage of structures listed in the Purpose column of the chart below refers to the footprint of the ground foundation.

COMMERCIAL/INDUSTRIAL SIGNAGE ALLOWED (excluding B-1)							
Purpose	Sign Type	Max Area per Face	# Faces	Max Height	Illumination	Number Signs	Electronic allowed?
Free standing Single Tenant Structures  <2,900 sf	Wall	80 sf	1	not to exceed highest roofline	Internal	1 per Facing Street/ Driveway	Yes, except Historic.
	Ground	120 sf	2	20 ft	Internal	1 per 500 ft of frontage	Yes, except Historic.
Free standing Single Tenant Structures  2,901 - 15,000 sf	Wall	80 sf	1	not to exceed highest roofline	Internal	1 per Facing Street/ Driveway	Yes, except Historic.
	Ground	160 sf	2	25 ft	Internal	1 per 500 ft of frontage	Yes, except Historic.
Free standing Single Tenant Structures  15,001 - 30,000 sf	Wall	200 sf	1	not to exceed highest roofline	Internal	1 per Facing Street/ Driveway	Yes, except Historic.
	Ground	200 sf	2	25 ft	Internal	1 per 500 ft of frontage	Yes, except Historic.
Free standing Single Tenant Structures  30,001 - 50,000 sf	Wall	200 sf	1	not to exceed highest roofline	Internal	1 per Facing Street/ Driveway	Yes, except Historic.
	Ground	210 sf	2	25 ft	Internal	1 per 500 ft of frontage	Yes, except

							Historic.
Free standing Single Tenant Structures 50,001 - 100,000 sf	Wall	220 sf	1	not to exceed highest roofline	Internal	1 per Facing Street/ Driveway	Yes, except Historic.
	Ground	220 sf	2	30 ft	Internal	1 per 500 ft of frontage	Yes, except Historic.
Building Front signs for Establishments in Multi-tenant Buildings (only allowed if store has frontage)	Wall or Projecting	Not covering more than 30% of store frontage	W: 1 P: 2	not to exceed roofline	Internal	1 per Facing Street/ Driveway	Yes, except Historic.
Multi-tenant Locator Signs ≤ 10,000 sf	Ground	100 sf ***	2	25 ft	Internal	1	Yes, except Historic.
Multi-tenant Locator Signs 10,001 - 30,000 sf	Ground	150 sf ***	2	30 ft	Internal	1 per Facing Street, total sign face area of all locator signs not to exceed 200 sf	Yes, except Historic.
Multi-tenant Locator Signs ≥ 30,001 sf	Ground	300 sf ***	2	35 ft	Internal	1 per Facing Street, total sign face area of all locator signs not to exceed 400 sf	Yes, except Historic.
Parking Lot Identification	Ground	32 sf	2	5 ft	Non-oscillating, concealed light source. (spotlight or floodlight prohibited)	1 per entrance	No

B-1 COMMERCIAL SIGNAGE ALLOWED							
Purpose	Sign Type	Max Area per Face	# Faces	Max Height	Illumination	Number Signs	Electronic allowed?

Business Identification	Ground	32 sf	2	5 ft	Direct, Indirect, or Internal	1 per facing street	no
Business Identification	Wall or Projecting	40 sf max - may not exceed 30% of the buildings frontage	W: 1 P: 2	W: 20 ft, or at Roofline, whichever is lower P: Min 9 ft above sidewalk	Direct, Indirect, or Internal	1 per facing street / driveway	no
Multi tenant Business Identification	Wall or Projecting	2 sf	1	W: 20 ft, or at Roofline, whichever is lower P: Min 9 ft above sidewalk	n/a	1 per tenant at the entrance of each tenants space	no
Parking Lot Identification	Ground	32 sf	2	5 ft	Non- oscillating, concealed light source. (spotlight or floodlight prohibited)	1 per entrance	no

D. OFFICE SIGNAGE

- The following Zones are considered "office use" for the purposes of these sign regulations: PO, and Office areas of a PUD or PDD

OFFICE SIGNAGE ALLOWED							
Purpose	Sign Type	Max Area per Face	# Faces	Max Height	Illumination	Number Signs	Electronic allowed?
Office Buildings ≤ 10,000 sf floor area	Ground	32 sf	2	5 ft	Direct, Indirect, or Internal	1 per Facing Street	no
Office Buildings ≤ 10,000 sf floor area	Wall or Projecting	32 sf	W: 1 P: 2	12 ft	Direct, Indirect, or Internal	1 per Facing Street/Driveway	no



Office Buildings ≥ 10,001 sf floor area	Ground	50 sf	2	9 ft	Direct, Indirect, or Internal	1 per Facing Street	no
Office Buildings ≥ 10,001 sf floor area	Wall or Projecting	32 sf	W: 1 P: 2	20 ft, or at Roofline, whichever is lower	Direct, Indirect, or Internal	1 per Facing Street/Driveway	no
Parking Lot Identification	Ground	32 sf	2	5 ft	Non- oscillating, concealed light source. (spotlight or floodlight prohibited)	1 per entrance to parking lot	no

E. OTHER SIGNAGE

OTHER SIGNAGE ALLOWED									
Zone	Purpose	Sign Type	Max Area per Face	# Faces	Max Height	Illumination	Setback	Number Signs	Electronic allowed?
OA	Identification	Ground	200 sf	2	25 ft	Indirect / Internal	25 ft	1 per entrance	yes
Promotional/Sponsorship materials within Park boundaries are exempt from the Sign Regulations									

22.6 - ELECTRONIC SIGN REGULATIONS

Electronic changeable copy (ECC) signs may be permitted as a detached freestanding or attached flat sign as follows:

- A. Not allowed in the City of Foley Historic Overlay District, regardless of zone.
- B. Allowed in zones: B1A, Extended Business District; B2, Neighborhood Business District; B3, Local Business District; M1, Light Industrial District; and Open Space/Preservation District.
- C. Allowed in the commercial or industrial portions of a Planned Zone (PID, Planned Industrial District; PUD, Planned Unit Development; or PDD, Planned Development District), when specifically included as a part of a Master Signage Plan (see section 22.5.D.1).

- D. The signs must meet all size and Vision Clearance Area requirements for the zoning and/or overlay district in which they are located.
- E. May not display messages that do not pertain to business conducted on the premises on which the sign is located, unless otherwise exempted or a public service announcement.
- F. Display of any message must be static. There shall be no effects of movement, flashing, scintillation, or similar effects in the individual images.

G. DETACHED FREESTANDING ELECTRONIC SIGN REQUIREMENTS

- a. The ECC sign must be located on the site of the use identified or advertised by the sign.
- b. No more than one (1) ECC sign with a maximum of two (2) parallel sides is permitted per lot of record.
- c. Lots with multiple businesses shall be allowed one (1) detached freestanding ECC sign to service all businesses located on that lot.
- d. ECC signs may not display colors, words, or images that interfere with or mimic a traffic control signal or device. (ie. - "STOP", "GO", "DANGER", etc.).
- e. Sign display technology shall be programmed so that the message or image on the sign changes ~~Electronic changeable copy signs shall change~~ no more than one (1) time per ten (10) seconds.
- f. Changes of image shall be substantially instantaneous as seen by the human eye and shall not use fading, rolling, window shading, flashing, spinning, rotating, dissolving, or similar effects as part of the change.
- g. Detached ~~electronic changeable copy~~ECC signs must form an integrated portion of an on-premises detached sign. The electronic changeable copy portion of the detached sign may be separated from the remainder of the sign. If the electronic message center portion of the sign is being utilized after sunset, the existing static portion of the sign must be functioning, illuminated, and readable.
- h. The area of the ~~electronic changeable copy~~ECC sign may comprise no more than fifty percent (50%) of the surface area of the allowable detached sign of which it is a part. Neither shall any portion of the ~~electronic changeable copy~~ECC sign project above the height of the permanent detached signage. ~~Electronic changeable copy signs~~ECC message centers are secondary to the permanent non-changeable portions of the sign and should be ~~designated~~designed in this regard.
- i. An ~~electronic changeable copy~~ ECC sign shall be included in the calculation of the total permitted sign area of the detached sign of which it is a part.
- j. ~~The sign must have a light sensing/dimming device to control the maximum light intensity. The sign should be dimmed down 90% to a minimum 10% brightness at night.~~ Electronic changeable copy signs must have an automatic dimmer control to produce a distinct illumination change from a higher illumination level to a lower level (10% of max brightness) for the time period between one-half hour before sunset and one-half hour after sunrise. In addition, it must also be able to respond to lighting level changes occurring due to atmospheric conditions.
- k. ~~Electronic changeable copy signs located within any residential district are allowed only for neighborhood identification signs and bed and breakfasts, as permitted by special~~



~~exception.~~—The leading edge of an ~~electronic changeable copy~~ ECC sign located in any district must be a minimum distance of one hundred (100) feet from an abutting occupied single-family residential district boundary. An ~~electronic changeable copy~~ ECC sign may not face an abutting residential district.

- i. ~~Electronic changeable copy~~ ECC signs must be separated from other ~~electronic changeable copy~~ ECC signs by at least fifty (50) feet.
- m. All ~~electronic changeable copy~~ ECC signs will be maintained in proper working order.
  - i. If at any time the programming or technology that controls the brightness, time/date on message, or any other required visual display characteristic fails or malfunctions and is determined to be a hazard to the safety of the traveling public, the sign shall be immediately turned off, disconnected or disabled.
  - ii. Any dead zones or non-illuminated portions of the signs shall be replaced or repaired within fourteen (14) working days, or as soon as possible conditions allowing, or the use of the sign shall be discontinued.
- n. If at any time subsequent to the adoption of this Section of the Zoning Ordinance any portion of these regulations is deemed to be a safety hazard by the City of Foley, the City reserves the right to modify said regulations and all existing signs shall be modified to conform to the safety-related modifications.

#### H. ATTACHED FLAT ELECTRONIC SIGN REQUIREMENTS

- a. A maximum of one (1) single sided attached ECC wall sign is permitted for a site that does not contain any other ~~electronic changeable copy~~ ECC sign, detached or wall mounted.
- b. Such signs may not exceed thirty-two (32) square feet in area and will be counted toward the calculation for maximum signage for the building and must comply with all other applicable provisions of this ordinance.
- c. Wall mounted signs shall not be oriented toward adjacent residential uses.

## 22.7 - SIGNS LOCATED IN OVERLAY DISTRICTS

If a property is located within an overlay district, that Overlay District's specific signage rules and relaxations will override the rules stated within Article XXII in the event of a conflict.

## ARTICLE XI - SITE PLAN REVIEW

### 11.1 SITE PLAN REVIEW

Site plans may be required to be submitted to the Planning Commission for input in cases where the proposed development meets the following criteria. The site plan approval will be valid for 12 months but will expire after this date if no building permits have been obtained. The Planning Commission may ~~extend the site plan approval if it is determined there is an extenuating circumstance~~ **grant one 1-year extension if no city regulations have been amended that would affect the site.**



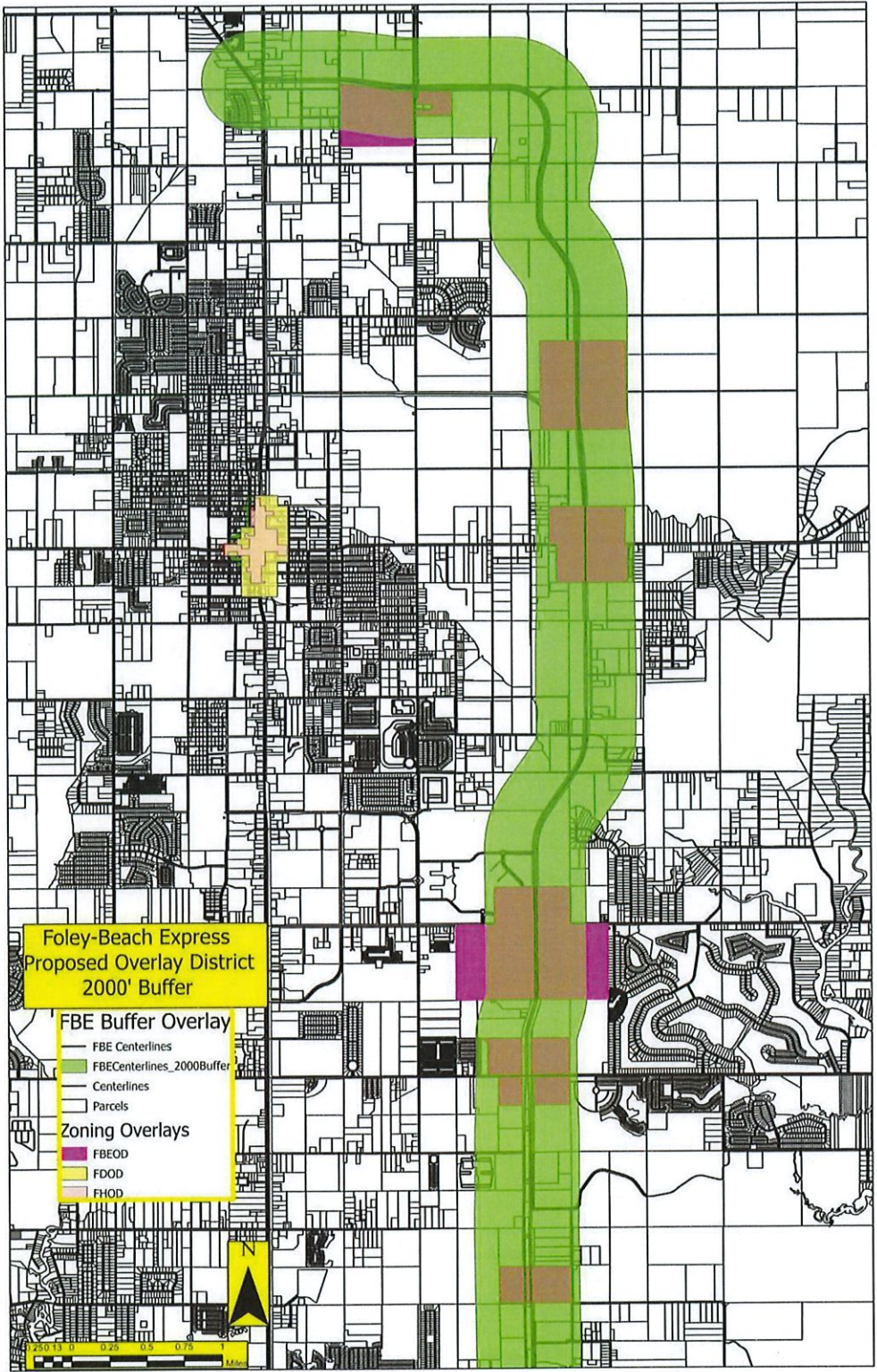

PASSED, ADOPTED AND APPROVED this 1st day of July, 2024.

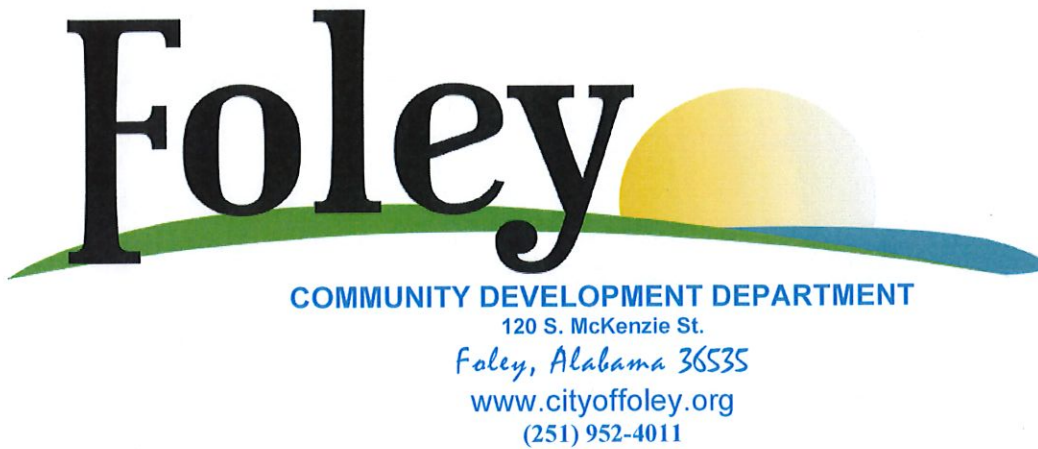

May 17, 2024

Mayor and City Council  
City of Foley  
407 East Laurel Avenue  
Foley, Alabama 36535

RE: Zoning Ordinance Amendments Recommendation

Dear Mayor Hellmich and City Council Members:

The City of Foley Planning Commission held a regular meeting on May 15, 2024 and the following action was taken:

**Zoning Ordinance Amendments**

Commissioner Engel made a motion to recommend the proposed Zoning Ordinance amendments to the Mayor and Council. Commissioner Hare seconded the motion. All Commissioners voted aye.

**Motion to recommend the proposed Zoning Ordinance amendments to the Mayor and Council passes.**

Please let me know if you have any questions or concerns.

Respectfully,

*Melissa Ringler*

Melissa Ringler  
Planning & Zoning Coordinator  
[mringle@cityoffoley.org](mailto:mringle@cityoffoley.org)

MAYOR: Ralph Hellmich

CITY ADMINISTRATOR: Michael L. Thompson

CITY CLERK: Kathryn Taylor

COUNCIL MEMBERS: J. Wayne Trawick; Vera Quaites; Richard Dayton; Cecil R. Blackwell; Charles Ebert III



**COMMUNITY DEVELOPMENT DEPARTMENT**

120 S. McKenzie St.

*Foley, Alabama 36535*

[www.cityoffoley.org](http://www.cityoffoley.org)

(251) 952-4011

**MAYOR:** Ralph Hellmich

**CITY ADMINISTRATOR:** Michael L. Thompson

**CITY CLERK:** Kathryn Taylor

**COUNCIL MEMBERS:** J. Wayne Trawick; Vera Quaites; Richard Dayton; Cecil R. Blackwell; Charles Ebert III



# Proposed Amendments to Miscellaneous Sections of Zoning Ordinance

Prepared by Eden Lapham, March 2023

## ARTICLE II - DEFINITIONS

### 2.1 DEFINITIONS APPLICABLE TO THIS ORDINANCE

**Dumpster Enclosure.** Dumpster / Trash enclosures are a structure built to provide shelter for a trash dumpster and for recyclable materials.

**Landscaping Material.** Living material including, but not limited to, trees, shrubs, vines, lawn grass, ground cover, and landscape water features. Non-living material may be used in such a manner as to present a finished appearance and to complete coverage, and may consist of pine or cypress bark, crushed pecan shell, pine straw, or other decorative mulch.

**Master Signage Plan (MSP):** A comprehensive document presented to and approved by the Planning Commission that contains a set of criteria and standards for present and future freestanding signage in common areas of a Planned Development in order to create a cohesive architectural statement. The MSP should identify locations of all expected signage and call out any requested relaxations of the standard sign regulations included in this zoning ordinance. The MSP may be modified as needed during site plan approvals through a Planned Development's progress in phases.

**Nit:** A term used to describe a unit of measure for luminance intensity per unit area that is projected in a given direction. A nit is equal to one candela per square meter. A nit measures the luminance of a light source which is closely related to the perceived "brightness" of the light source.

**Open Space:** Land which is landscaped or left in a natural state and is intended for natural or scenic preservation and/or active / passive recreational uses and their accessory Structures. Where minimum Open Space reservation percentages of a development are required per the Zoning Ordinance, the percentage amount and use restrictions are detailed in the individual zone. The City's Land Development Ordinance also contains "Conservation Area" or "Green Space" requirements that must be met in conjunction with the Zoning Ordinance Open Space requirements.

**Parking Space:** The space necessary to park an automobile which shall not be less than an area ten (10) feet wide by twenty (20) feet long for perpendicular parking spaces and nine (9) feet by twenty (20) feet for a herringbone/angle design. All parking spaces required shall be provided along with necessary lanes and maneuvering areas. Size requirements are defined in Article 10. No two-way entrance or aisle shall be less than twenty-five (25) feet in width. In no event shall an entrance or aisle be less than twenty (20) feet.

**Planned Developments:** Planned Developments include Townhomes, Multi-Family and Mixed Use developments R3 Residential Multi-Family, TH-1 Residential Townhouse, PUD Planned Unit Development, PDD Planned Development District, MH-1 Mobile/Manufactured Dwelling Parks, RV Recreational Vehicle Parks and PID Planning Industrial Districts. These zones require a master plan layout prior to zoning / rezoning. The approved layouts then become the "zoning" for these properties and are considered site plan approval as well unless otherwise noted in the meeting minutes. The

approved layouts can only be modified by the Planning Commission and in certain instances will require City Council approval as well.

Sign, Changeable Copy: A sign upon which the copy may be manually changed, rearranged, or altered or removed without altering the structure of the sign face or support.

Site Plan: The plan drawings of a proposed development on a lot or lots which reflects the existing conditions and proposed changes, including drainage, and any other possible environmental impact.

Sign, Monument: A sign mounted to the ground and designed with a continuous structural element of approximately the same dimension from the ground to the top of the sign.

Storage Structures / Open Space Storage: A structure, groups of structures or open space intended, designed, or capable of being used as rental storage facilities to individuals, businesses or other entities. Said definition shall also include the term "mini-warehouse", "boat", "RV" and other similar storage facility-facilities.



# ARTICLE III - PURPOSE AND METHOD

## 3.3 ZONING DISTRICT Classification Chart

Designation	General Use	Specific Use
R-1R	Residential Zone	Restricted Single Family
R-1A	Residential Zone	Single Family
R-1B	Residential Zone	Single Family
R-1C	Residential Zone	Single Family
R-1D	Residential Zone	Single Family
R-2	Residential Zone	Single Family & Two Family
R-3	Residential Zone	Multi-Family
R-4	Residential Zone	Single Family & Two Family
GPH-1	Residential Zone	Garden-Patio Homes
TH-1	Residential Zone	Townhouses
MH-1	Residential Zone	Mobile Home/Park Subdivision
<b>RV</b>	<b>Special Use</b>	<b>RV Park - short term rentals</b>
PUD	Special Use	Planned Unit Development
PDD	Special Use	Planned Development District
PID	Industrial Use	Planned Industrial District
B-1	Commercial Use	Central Business District
B-1A	Commercial Use	Extended Business District
B-2	Commercial Use	Neighborhood Business District
B-3	Commercial Use	Local Business District
PO	Office Zone	Preferred Office District
M-1	Industrial Zone	Light Industry
A-O	Agriculture	Open Space / Agricultural Use
OSP	Parks/Public Land	Open Space / Preservation District
<b>PUBLIC USE</b>	<b>Government/Public Use</b>	<b>Parks and Buildings for Public Use</b>
<b>H</b>	<b>Historic Overlay</b>	<b>Overlying Area of Historic District</b>
<b>FDOD</b>	<b>Foley Downtown</b>	<b>Overlay of Downtown</b>



## ARTICLE IX - COMMERCIAL – MISCELLANEOUS

Dumpster / Trash Enclosures are considered accessory structures for setback, location and similar purposes. Please refer to Engineering / Public Works for specific design criteria.

## ARTICLE XIII - DISTRICT REGULATIONS

### 13.1.1 USES / STRUCTURES PERMITTED

Unless specifically prohibited in a particular zoning district, the following uses and structures are permitted by right in all districts.

A. ~~Public utilities, excluding electric and gas substations and water / wastewater pumping stations;~~

## ARTICLE X - PARKING, LANDSCAPING, BUFFER, & LIGHTING REQUIREMENTS

10.1.D.7. Warehouses, Storage Structures / Open ~~Space Storage~~ – 1 space for each 3,000 sq. ft. of gross floor area.

### 10.1.E Parking space and aisle size requirements:

1. Perpendicular spaces - 10 ft wide by 20 ft long
2. Herringbone/Angle spaces - 9 ft wide by 20 ft long
3. One way traffic parking lot aisle width - 20 ft minimum
4. Two way traffic parking lot aisle width - 25 ft minimum

### 10.1.1. USE AND MAINTENANCE OF PARKING LOTS (NON-RESIDENTIAL)

Off-street parking for non-residential uses:

- A. Required parking must be designated by pavement, gravel, cross-ties or some similar method.
- B. Shall not be used for the parking or storage of automobile trailers, boat trailers, non-motorized recreational vehicles and similar vehicles.

### 10.3 Exterior Lighting Requirements

A. Purpose and Intent: The purpose of this regulation is to minimize light pollution, glare, and light trespass by establishing guidelines for exterior lighting applications. These regulations aim to ensure that outdoor lighting enhances safety and visibility while minimizing adverse impacts on the night sky and neighboring properties.

B. Application Requirements:

1. Exterior lighting plans are required for all projects other than single family residential. An exterior lighting plan, including a photometric plan (which covers the parcel which is the site of the building or project in question), appropriate pole, fixture, and lamp cut sheets, and descriptions of lenses and appropriate data tables, shall be submitted for review during the site plan approval process.
2. All applications for exterior lighting installations must include the following:
  - a. Photometric Plans: A detailed photometric plan covering the entire site must be submitted. The plan should demonstrate the distribution of light and ensure



compliance with the requirements outlined in this regulation. Photometric plans must be prepared by a licensed professional engineer or lighting designer.

b. **Fixture Specifications:** Complete specifications for all lighting fixtures proposed for installation, including cut sheets, must be provided. This should include information on the fixture type, wattage, shielding, and any additional features designed to minimize light pollution, glare, or spill light.

c. **Mounting Heights:** Proposed mounting heights for lighting fixtures should be specified, ensuring that fixtures are positioned to minimize upward light and glare.

d. **Control Measures:** Applicants must outline any proposed control measures, such as timers, motion sensors, or dimmers, intended to minimize unnecessary or excessive lighting during non-operational hours.

#### C. Photometric Performance Requirements:

1. **Light Distribution:** Lighting fixtures must be selected and positioned to achieve uniform light distribution across the site, with emphasis on minimizing upward light and spill light onto adjacent properties.

2. **Cutoff Fixtures:** All lighting fixtures must be cutoff fixtures, designed to limit upward light emissions and glare.

3. **Spill Light Control:** Measures must be implemented to minimize spill light onto adjacent properties. This may include the use of shields, baffles, or other appropriate methods to direct light downward and confine it within the boundaries of the property.

#### D. Illumination Levels:

1. **Maximum Intensity:** The maximum illumination levels at the property line should not exceed 0.5 footcandles when adjacent to residential properties and 1.0 footcandles when adjacent to other uses. These levels should be maintained throughout the operational hours of the lighting system.

2. **Gradual Dimming:** Lighting systems must incorporate gradual dimming controls to reduce illumination levels during non-operational hours, minimizing light pollution and unnecessary energy consumption.

E. **Prohibitions:** The installation, retrofitting, or modification of wall pack lighting fixtures, as well as any similar fixtures attached to exterior walls and characterized by outward-facing design and emitting excessive glare and spill light, is strictly prohibited.

#### F. Compliance and Enforcement:

1. **Inspections:** Compliance with this regulation will be verified through site inspections conducted by authorized personnel.

2. **Penalties:** Non-compliance with the requirements of this regulation may result in penalties, including fines and the requirement to modify or remove non-compliant lighting installations.

G. **Exemptions:** While the following are exempt from certain provisions of this regulation but must still adhere to the principles of minimizing light pollution, glare, and light trespass to the greatest extent possible.

1. **Emergency lighting necessary for safety and security purposes is exempt from certain provisions of this regulation but must still adhere to the principles of minimizing light pollution, glare, and light trespass to the greatest extent possible.**

2. **Exemptions from the provisions of this ordinance are permitted when federal or state laws, rules, and regulations take precedence over these provisions.**

3. **Public schools.**



4. Recreational sporting venues owned by the City

H. Applicability: This regulation applies to all new exterior lighting installations and modifications to existing installations within the City.

I. Definitions:

1. Photometric Plans: Detailed diagrams illustrating the distribution and intensity of light across a site, typically prepared by a licensed professional engineer or lighting designer. These plans provide critical information for assessing the performance of exterior lighting installations and ensuring compliance with regulatory standards.
2. Footcandle (f.c.): A unit of illuminance measuring one lumen per square foot.
3. Control Measures: Strategies and mechanisms implemented to regulate the operation of lighting systems, including timers, motion sensors, dimmers, and other devices intended to minimize unnecessary or excessive lighting during non-operational hours.
4. Light Distribution: The manner in which light is spread or dispersed across a given area, aiming to achieve uniform illumination while minimizing glare, hot spots, and uneven lighting. Proper light distribution is essential for optimizing visibility and safety in outdoor environments.
5. Cutoff Fixtures: Outdoor lighting fixtures designed to limit the upward emission of light and control glare by utilizing shielding or other mechanisms to direct light downward. Cutoff fixtures help minimize light pollution and prevent unnecessary illumination of the night sky.
6. Spill Light Control: Measures implemented to minimize the unintended projection of light beyond the boundaries of a property, reducing light trespass onto adjacent properties and minimizing the adverse effects of glare and excessive illumination.
7. Maximum Intensity: The maximum allowable level of illumination at the property line, typically expressed in footcandles (fc). Maximum intensity standards help ensure that lighting installations do not produce excessive glare or spill light onto neighboring properties, contributing to a more visually comfortable and environmentally responsible outdoor lighting environment.
8. Gradual Dimming: A feature of lighting systems that allows for the gradual reduction of illumination levels during non-operational hours. Gradual dimming controls help minimize light pollution, conserve energy, and promote responsible outdoor lighting practices by adjusting lighting levels to match changing environmental conditions and usage patterns.
9. Emergency Lighting: Lighting systems designed to provide illumination during emergency situations, such as power outages or evacuations, to ensure the safety and security of occupants. While emergency lighting is exempt from certain provisions of exterior lighting regulations, it is still subject to requirements aimed at minimizing light pollution, glare, and light trespass.
10. Wall pack lighting fixtures are defined as outdoor lighting fixtures designed to be attached directly to exterior walls, characterized by their outward-facing design and tendency to emit excessive glare and spill light.

## ARTICLE XI - SITE PLAN REVIEW

Site plans may be required to be submitted to the Planning Commission for input in cases where the proposed development meets the following criteria. Please note that site plan criteria for planned developments falls under a different category - see Definition. The site plan approval will be valid for



12 months but will expire after this date if no building development / building permits have been obtained. The Planning Commission may extend the site plan approval if it is determined there is an extenuating circumstance, engineering & environmental permits are in process or if a portion of the building permits have been pulled for the project. A new site plan meeting the most current regulations may be submitted for Planning Commission review & consideration.

## ARTICLE XIV - SINGLE FAMILY RESIDENTIAL & DUPLEX DISTRICTS

### 14.1.1 R-1R RESTRICTED RESIDENTIAL SINGLE FAMILY

D. Requirements:

Garage Setback (Front Loaded) 40'

### 14.1.2 R-1A RESIDENTIAL SINGLE FAMILY

D. Requirements:

Garage Setback (Front Loaded) 40'

### 14.1.3 R-1B RESIDENTIAL SINGLE FAMILY

D. Requirements:

Garage Setback (Front Loaded) 40'

### 14.1.4 R-1C RESIDENTIAL SINGLE FAMILY

D. Requirements:

Garage Setback (Front Loaded) 40'

### 14.1.5 R-1D RESIDENTIAL SINGLE FAMILY

D. Requirements:

Garage Setback (Front Loaded) 40'

### 14.1.6 R-2 RESIDENTIAL SINGLE FAMILY AND DUPLEX

D. Requirements:

SINGLE FAMILY:

Garage Setback (Front Loaded) 40'

DUPLEX:

Minimum Lot Area (duplex) 11,500 square feet\*

Landscape Requirements (duplex) 10% of Minimum lot area

Garage Setback (Front Loaded) 40'

DEFINITIONS:

i. Architectural Details - Include but are not limited to: porch railings; column size, taper, base and molding; dormer windows; shutters; transparency; and similar.

ii. Building Facade Recesses - Porches or patios

iii. Landscaping - An area of mixed vegetation along the primary facade facing the street. Landscaping can consist of trees and/or shrubs. See Definition of "Landscaping Material".

### 14.1.7 R-4 RESIDENTIAL SINGLE FAMILY AND DUPLEX

D. Requirements:

**SINGLE FAMILY:**

Garage Setback (Front Loaded) 40'

**DUPLEX:**

Minimum Lot Area (duplex) 11,500 square feet\*

Landscape Requirements (duplex) 10% of Minimum lot area

Garage Setback (Front Loaded) 40'

**DEFINITIONS:**

iv. Architectural Details - Include but are not limited to: porch railings; column size, taper, base and molding; dormer windows; shutters; transparency; and similar.

v. Building Facade Recesses - Porches or patios

vi. Landscaping - An area of mixed vegetation along the primary facade facing the street. Landscaping can consist of trees and/or shrubs. See Definition for "Landscaping Material".

**14.1.8 GPH-1 RESIDENTIAL GARDEN PATIO HOMES**

**D. Requirements:**

Garage Setback (Front Loaded) 40'

**ARTICLE XVI - MANUFACTURED HOMES**

**16.1.3.C Required Open Space:**

1. Each mobile / manufactured dwellings park shall provide land for open space which may be used for recreational purposes, but which may not be used for parking or for accessory structures. Such open space shall total at least fifteen percent (15%) of the gross land area of the park. This requirement does not apply to mobile / manufactured dwellings subdivisions.

2. Mobile / manufactured dwellings subdivisions greater than five (5) acres in total area shall include, at a minimum, open space equal to ten percent (10%) of the total area. Such open space may be used for recreational purposes, but may not be used for parking or accessory structures.

3. The City's Land Development Ordinance also contains guidance and requirements for Conservation Green Space that must be met in conjunction with this Zoning Ordinance Open Space requirement.

**ARTICLE XVII - RECREATIONAL VEHICLE (RV) PARK**

**17.1.3 GENERAL REQUIREMENTS**

**17.3.D** Minimum 25% open space excluding required stormwater / drainage. The minimum 25% shall be reserved collectively in contiguous units accessible to all the RV sites and maintained by the property owners. This open space is to be used for: accessory uses, parks, recreation facilities, sidewalks, clubhouse, pool, and similar. The City's Land Development Ordinance also contains guidance and requirements for Conservation Green Space that must be met in conjunction with this Zoning Ordinance Open Space requirement.



## **ARTICLE XVIII - COMMERCIAL / OFFICE DISTRICTS**

**18.1.1.B** - Uses / Structures Permitted on Appeal: Automobile filling stations, motels, automobile repair (minor and major), large dry cleaners and laundries, veterinary clinics / hospitals, manufacturing incidental to a retail business where articles are sold at retail on the premises, other uses not specifically restricted herein; storage structures / open **space storage**; home based businesses; and home occupations.

**18.1.2.B** - Uses / Structures Permitted on Appeal: Automobile repair (major); large dry cleaners and laundries, veterinary clinics/hospitals, manufacturing incidental to a retail business where articles are sold at retail on the premises, other uses not specifically restricted herein; storage structures / open **space storage**.

**18.1.3.B** - Uses / Structures Permitted on Appeal: Large dry cleaners and laundries; veterinary clinics and hospitals; automobile repair (major), manufacturing incidental to a retail business where articles are sold at retail on the premises, wholesale businesses, storage structures / open **space storage**.

**18.1.4.B** - Uses / Structures Permitted on Appeal: Veterinary clinics / hospitals; kennels; wholesale; storage structures / open **space storage**.



# ARTICLE XXI - PLANNED DEVELOPMENTS

## 21.1.1 R-3 Residential Multi-Family

- **E.6.b** - Include sufficient open spaces in the form of squares, greens and parks. A minimum of 25% of open space shall be provided in all multiple family developments. Stormwater retention areas are not included in this 25% open space requirement, unless it is properly designed and determined to be acceptable open space by the Planning Commission. **The City's Land Development Ordinance also contains guidance and requirements for Conservation Green Space that must be met in conjunction with this Zoning Ordinance Open Space requirement.**

## 21.1.2 TH-1 Residential Townhouse

- D. Requirements:

Minimum Area	1 acre
Minimum Lot Area	2,400 square feet*
Minimum Lot Width at Building Line	<b>25 24 feet</b>
Minimum Depth of Front Yard	20 feet
Minimum Depth of Rear Yard	15 feet
Minimum Width of Side Yard (on end unit)	16 feet
Minimum Depth of Side Yard Abutting Street	16 feet
<b>Minimum Open Space if &lt;5 ac</b>	<b>20%</b>
<b>Minimum Open Space if ≥5 ac</b>	<b>25%</b>
Maximum Building Height (feet):	50 feet
Maximum Building Height (stories):	3
Off-Street Parking Spaces (per family unit)	2
Maximum Density Per Acre	15

\* or meet Health Department requirements.

- H.9 - Townhouse developments with a total area less than five (5) acres shall have at least twenty (20) percent common open space and five (5) acres or greater shall have at least twenty-five (25) percent of the total area devoted to common open space, exclusive of parking areas, accessory buildings, or required drainage. Such common open areas may include recreational facilities. In addition, the developer of a townhouse development or homeowners association created by the developer by recorded covenants and restrictions, shall preserve for the owners and occupants of the development such lands set aside for open areas, parks, or recreational use, and the common off-street parking spaces established for the development. **The City's Land Development Ordinance also contains guidance and requirements for Conservation Green Space that must be met in conjunction with this Zoning Ordinance Open Space requirement.**

## 21.2.1 PUD - PLANNED UNIT DEVELOPMENT

- **C.7** - Open Space Reservation: Not less than 25% of the PUD site shall be reserved collectively in contiguous units accessible to all the building sites in the PUD and maintained by the property owners for open space for the purpose of providing parks, recreational facilities, ways for pedestrian movement and circulation, and for conserving visually pleasing elements of the environment. This open space does not include areas reserved for drainage purposes. If the PUD is developed in stages, the amount of open space reserved and developed for use in

each stage will constitute no less than an equivalent proportional amount to the area being developed. The City's Land Development Ordinance also contains guidance and requirements for Conservation Green Space that must be met in conjunction with this Zoning Ordinance Open Space requirement.

#### **21.5 PDD – PLANNED DEVELOPMENT DISTRICT**

G. There shall be a minimum of at least twenty percent of the gross lot area (20%) designated open space in a PDD exclusive of all drives, walkways, parking areas and required drainage. Access roads and drainage infrastructure, water, sewer, electricity, telephone and other utilities shall be provided to serve the development at the completion of construction of each development phase. Performance bonds may not be posted for drainage and sewer work. The City's Land Development Ordinance also contains guidance and requirements for Conservation Green Space that must be met in conjunction with this Zoning Ordinance Open Space requirement.

## **ARTICLE XXV - OVERLAY DISTRICTS**

#### **25.2 FOLEY ZONING MAP**

A layer defining the Historic Overlay District boundary will be provided in the online Foley Zoning Map. ~~The Foley Zoning Map shall be amended and shall reflect the designation of the Historic District Overlay according to the Historic District Overlay Boundaries and the letter H added as a suffix to the underlying zoning district(s).~~

#### **25.8 ESTABLISHMENT OF FDOD BOUNDARIES**

A map of the FDOD overlay boundary is included in the Zoning Ordinance (see Appendix Exhibit A), and a layer containing the FDOD boundary will be provided in the online Foley Zoning Map. ~~The Foley Zoning Map shall reflect the designation of the Foley Downtown Overlay District according to the Foley Downtown Overlay District Boundaries and the letters FDOD added as a suffix to the underlying zoning district(s).~~



# Proposed Amendments to ZO - Signs

Prepared by Eden Lapham, March 2023

*Anything left white in the proposed version below is the original wording from the current ordinance, but it may be placed in a different order than it was before. Changes are highlighted in yellow (strikethrough where deletions occur).*

## **ARTICLE XXII - SIGN REGULATIONS**

### **22.1 GENERAL PROVISIONS**

### **22.2 PROHIBITED SIGNS**

### **22.3 TEMPORARY SIGNS NOT REQUIRING PERMITS**

### **22.4 TEMPORARY SIGNS REQUIRING AN EXEMPT PERMIT**

### **22.5 SIGNS REQUIRING A PERMIT**

### **22.6 ELECTRONIC SIGN REGULATIONS**

### **22.7 SIGNS LOCATED IN OVERLAY DISTRICTS**

## **ARTICLE XXII - SIGN REGULATIONS**

The purpose of these sign regulations are: to encourage the effective use of signs as a means of communication; to maintain and enhance the aesthetic environment and the city's ability to attract sources of economic development and growth; to improve pedestrian and traffic safety; to minimize the possible adverse effect of signs on nearby public and private property; and to enable the fair and consistent enforcement of these sign restrictions. This sign ordinance is adopted under the zoning authority of the city in furtherance of the more general purposes set forth in the Zoning Ordinance.

### **22.1 - GENERAL PROVISIONS**

A. PERMITS REQUIRED - Except as otherwise provided in this Ordinance, it shall be unlawful for any person to erect, construct, enlarge, move, alter or convert any sign in the City or cause the same to be done, without first obtaining a Building Permit for each sign from the Building Official.

1. APPLICATION FOR PERMIT - The City's online application process shall be followed to request a sign permit. The following information is required to assure compliance with all appropriate laws and regulations of the City:

- a. Name and address of owner of the sign.
- b. Name and address of owner or the person in possession of the premises where the sign is located or to be located.
- c. Clear and legible drawings with description definitely showing the location of the sign which is subject of the permit and all other existing signs for that particular business at that location. Signs located at intersections should also provide required Vision Clearance Areas on the drawing as defined in section 22.1.D below.
- d. Drawings showing the dimensions, construction supports size, electrical wiring, components, illumination method, materials of the sign and method of support.
- e. If the sign is or will be located within the Local Downtown Historic District, a Certificate of Appropriateness (COA) must be received prior to permit application.



2. DENIAL OF PERMIT - When a permit is denied by the Community Development Director, notice shall be given to the proper applicant with a written statement of the reason or reasons for the denial. Said statement shall be made as an attachment to the permit application.
  3. APPEAL OF PERMIT DENIAL - If the denial is based on the interpretation or enforcement of the Zoning Ordinance, any aggrieved party may appeal the decision or interpretation of the Community Development Director to the Zoning Board of Adjustment and Appeals.
  4. USES PERMITTED AND USES PERMITTED ON APPEAL - Signs allowed for Article XIII - District Regulations (Section 13.1.1 "Uses Permitted", and Section 13.1.2 - "Uses Permitted on Appeal") shall meet the requirements of the zoning district in which they are located.
  5. PERMIT EXCEPTIONS - The following activities shall not require a permit from the City of Foley, but the sign shall comply with the other provisions of this ordinance:
    - a. Altering the advertising copy or message on an existing approved sign or marquee which is specifically designed for the use of replacement copy.
    - b. Painting, cleaning or other normal maintenance and repair of a sign not involving structural changes.
- B. MAINTENANCE / UNSAFE SIGNS - Every sign in the City shall be maintained in good structural condition. The Community Development Director may inspect and shall have the authority to order the painting, repair, alteration or removal of signs which become dilapidated or abandoned or which constitute a physical hazard to public safety. Any repair, painting, alteration, or removal will be at the sign owner's expense.
- C. LOCATION
1. All signs shall be on premise and may not extend beyond the property lines of the property on which the sign is located nor interfere with any public right-of-way or public easement, except as permitted specifically within this Ordinance or other City ordinances.
  2. No signs shall be erected in public right-of-way or on public sidewalks, except those necessary for regulatory, statutory or traffic control purposes, or other directional signs placed by the City of Foley, Baldwin County, the State of Alabama, or the United States.
- D. VISIBILITY
1. No sign shall be located so as to cause a public hazard, obstruct or impair motorists' vision, diminish safe ingress and egress to any property or impede flow of pedestrian or vehicular circulation in parking areas, sidewalks, or public roads.
  2. Signs may not be located within the vision clearance areas, the triangular shaped areas located at the intersection of any combination of streets, alleys or driveways (as defined below). Nothing may be erected, placed, planted or allowed to grow in such a manner as to limit or obstruct the sight distance of motorists entering or leaving the intersection. The sides of the triangle extend from the intersection of the pavement or other vehicle travel areas.
    - a. Required Vision Clearance Area distances

Visibility Requirement by Street Classification				
A Distance in Feet	Street Type	B Distance in Feet		
		Driveway	Local Street	Collector/Arterial
25	Driveway	25	30	100



30	Local Street	25	30	100
100	Collector/Arterial	25	30	100

b. Vision Clearance Areas

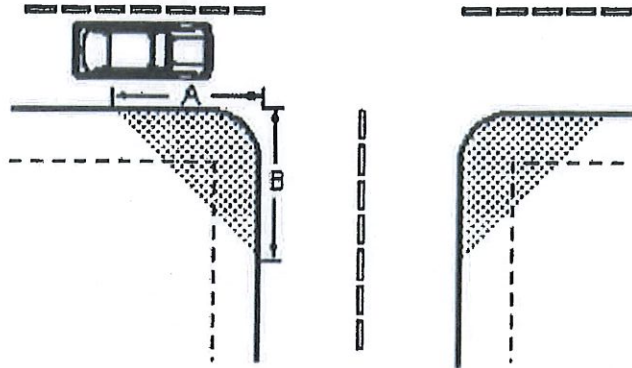

3. Signs must be located to provide unobstructed visibility and shall not be located between the heights of two and one-half (2 1/2) feet and ten (10) feet from grade within the Vision Clearance Areas. Structures and supports must have a combined total width of 12 inches or less and the combined total depth of 12 inches or less.

a. Vision Clearance Area Height

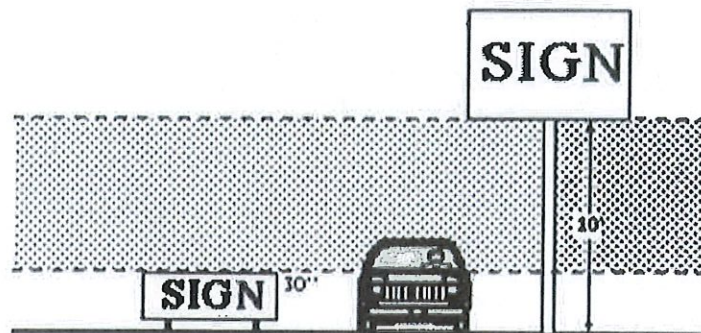

**E. MEASUREMENT AND CALCULATION STANDARDS**

**1. SIGN HEIGHT**

- The height of a sign shall be computed as the distance from the base of the sign at normal grade (average grade at the base of the sign) to the top of the highest attached component of the sign.
- Normal grade shall be construed to be the newly established grade after construction, exclusive of any filling, berming, mounding, or excavating solely undertaken for the purpose of locating or increasing the height of sign.

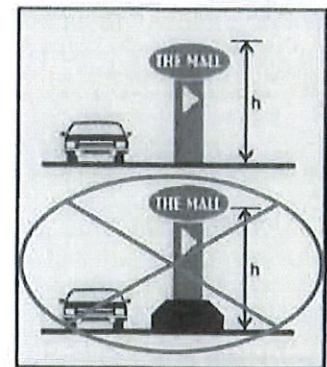

**2. SIGN WIDTH**

- The width of a sign shall be measured across the widest portion of a sign that runs parallel to the ground at the base of the sign.

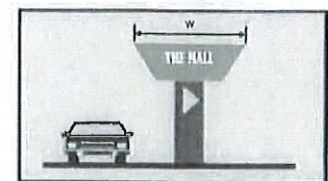



- b. The sign width shall include all structure elements of a sign (e.g., support posts, sign cabinet, etc.).

### 3. SIGN FACE AREA

- a. For sign copy mounted or painted on a background panel, cabinet, or surface distinctively painted, textured, lighted, or constructed to serve as the background for the sign copy, the sign area shall be computed by means of the smallest square, circle, rectangle, triangle, or combination thereof that encompasses the extreme limits of the background panel, cabinet, or surface.

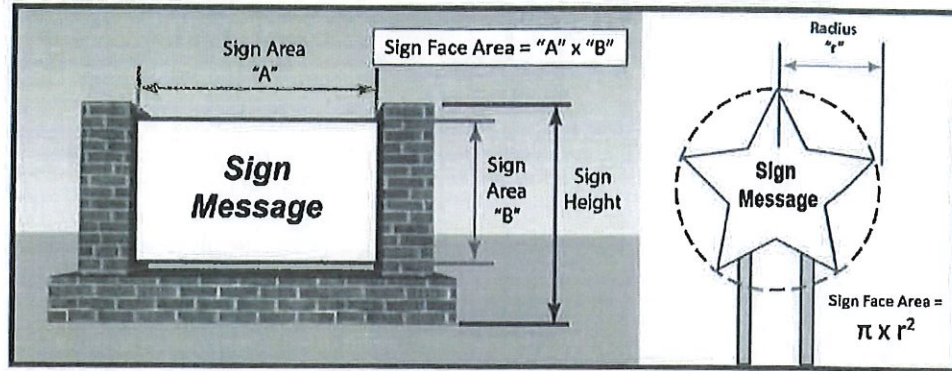

- b. For sign copy where individual letters or elements are mounted or painted on a building façade where there is no background panel, cabinet, or surface distinctively painted, textured, lighted, or constructed to serve as the background for the sign copy, the sign area shall be computed by means of the combination of the smallest square, circle, rectangle, triangle, or combination thereof that encloses all the letters or elements associated with the sign.

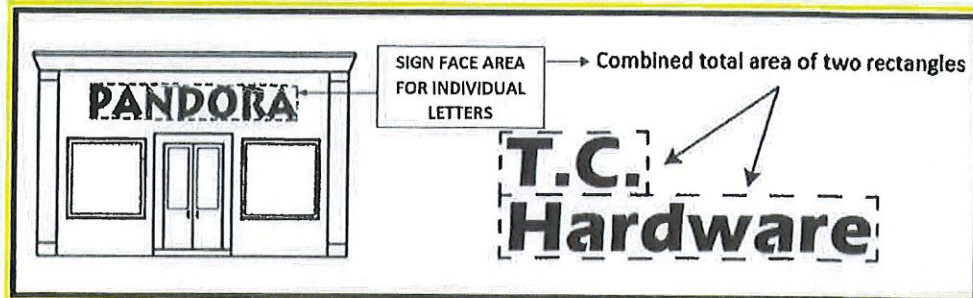

- c. The calculation of sign area shall not include any supporting framework, bracing, or decorative fence or wall unless such structural support is determined to constitute an integral part of the sign design by means of text or other commercial message, as determined by the Community Development Director.

### F. SIGN TYPES

1. **DETACHED SIGNS** - Any sign supported by structures or supports that are placed on, or anchored in, the ground and that are independent from any building or other structure.
  - a. **Monument Signs** - A sign mounted to the ground and designed with a continuous structural element of approximately the same dimension from the ground to the top of the sign.
  - b. **Pole/Pylon Signs** - Any sign supported by a pole, or poles, and otherwise separated from the ground by air.
  - c. **Multi-tenant Locator Signs** - A single ground sign which identifies multiple businesses which are all tenants in a single structure, shopping center or complex.



Must be located on the property that is being leased by the businesses who are displayed on the sign face unless otherwise allowed in this ordinance.

- d. Incidental/**Directional** Signs - A sign, generally informational, such as "no parking", "entrance", "exit", "loading only", "drive-through", "menu boards", and other similar directives. No sign with a commercial message legible from a position off the zoned lot on which the sign is located shall be considered incidental.

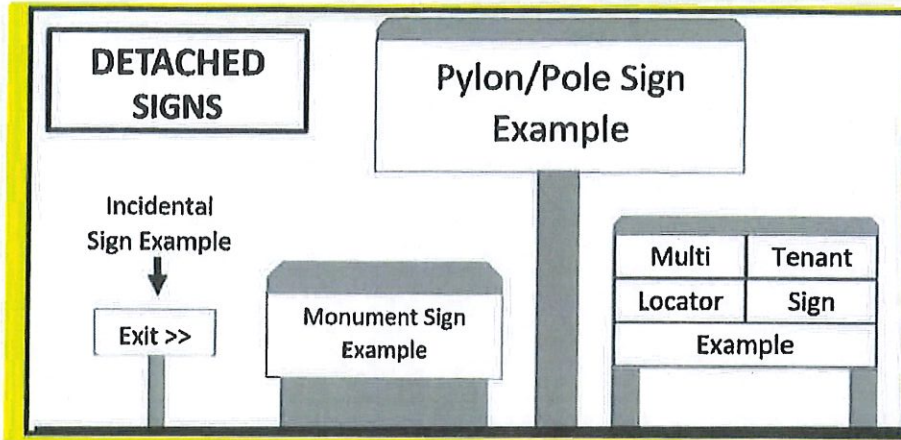

## 2. ATTACHED SIGNS

- a. Wall Signs - A sign entirely affixed directly to the wall of a building or the slope of a mansard-type roof, and/or projecting to a point less than twelve (12) inches beyond the wall surface.
- b. Suspended/**Hanging** Signs - A sign that is suspended from the underside of a horizontal plane surface and is supported by such a surface.
- c. Projecting Signs - Any sign affixed to any building or structure, extending beyond the building wall, structure, or building line by more than twelve (12) inches and no more than eighteen (18) inches. (For Local Downtown Historic District properties, refer to the Design Guidelines)
- d. Canopy/**Awning** Signs - Any sign that is a part of or attached to an awning, canopy, or other fabric, plastic, or structural protective cover over a door, entrance, window, or outdoor service area. A marquee is not a canopy.
- e. Marquee Signs - A projecting sign which is attached to or hung from a canopy, or a covered structure projecting from or supported by a building, extending beyond the building line.
- f. Mural Signs - A decoration or artwork painted on the exterior wall of a building which may be classified as a sign when it contains lettering, trade emblems or logos. When such items are incorporated, the sign specifications shall be as follows:
1. Lettering- shall be localized and the area measured to conform to the size limitations of this Ordinance.
  2. Trade emblems and logos- the entire area of the mural shall be considered to be the sign face area and shall meet the size limitations contained in this Ordinance.
- g. Painted Wall Signs - A sign that is not a mural, but which is painted directly on the surface of a structure.
- h. Window Signs - Any sign, pictures, symbol, or combination thereof, designed to communicate information about an activity, business, commodity, event, sale or service, that is placed inside a window or upon the window panes or glass and is visible from the right-of-way.

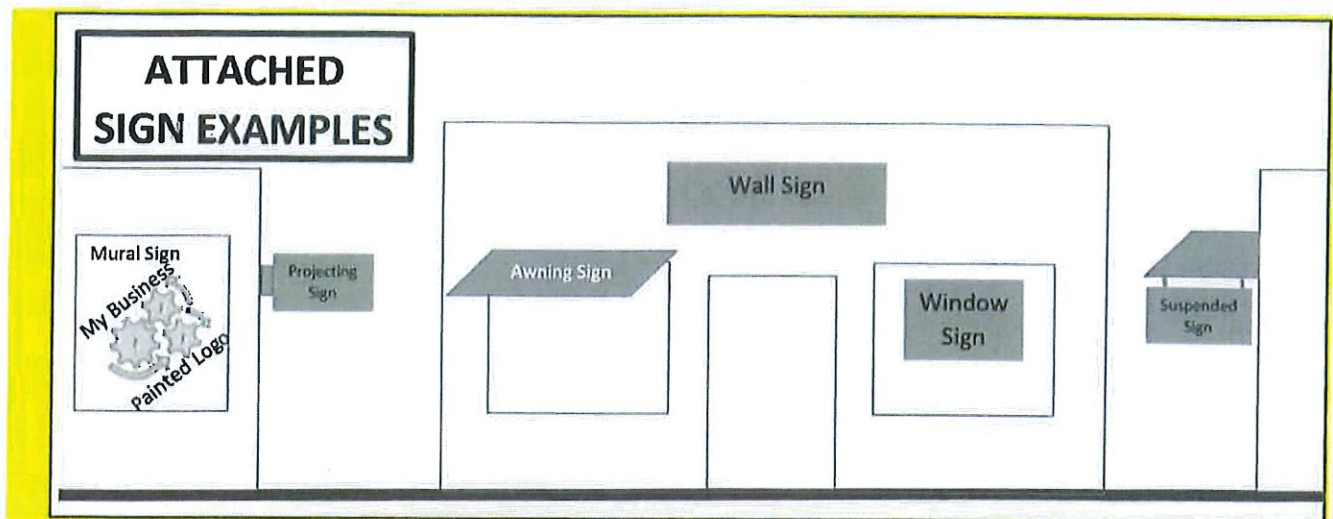

### 3. METHODS OF ILLUMINATION

- a. DIRECT - Light sources, including spotlights and neon tubing, which is attached to the sign face or structure and directed toward the copy area.
- b. INDIRECT - Light sources not attached to the sign structure or face area, but which are designed to be directed onto the sign face area.
- c. INTERNAL - Light sources enclosed in a sign face.
- d. ELECTRIC MESSAGE CENTER - Light sources arranged in rows, intended and designed to be individually and sequentially lit in such a manner to form letters and/or graphics which may blink on and off, travel, or flash. (See section 22.6 for further details and requirements.)

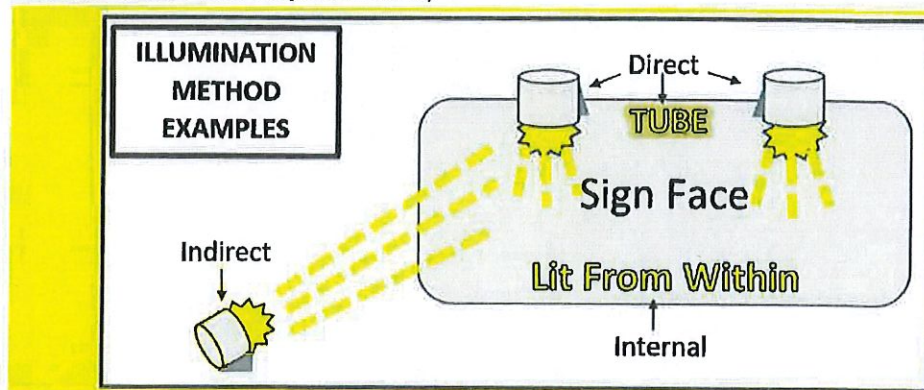

### G. NON-CONFORMING SIGNS

1. SIGNS ELIGIBLE TO BE CONSIDERED "LEGAL NON-CONFORMING" - Any sign located within the city limits on the date of the adoption of this Ordinance or located in any area annexed to the City hereafter which does not conform to the provisions of this Ordinance, is eligible for characterization as a "Legal Non-Conforming" sign and is permitted, provided it meets the following requirements:
  - a. A permit had been issued for the construction of such sign prior to the date of the adoption of this Ordinance, if one was required under any other or prior city ordinance, or if no sign permit was required under any prior applicable City ordinances for the sign in question, the sign must have been in compliance with the prior applicable City ordinances as of the date of the adoption of this Ordinance.



- b. If a sign was in compliance with all applicable regulations and laws prior to being annexed into the City of Foley, but is either prohibited or fails to conform with the Zoning Ordinance after annexation, then such sign may be considered a legal non-conforming sign.
2. LOSS OF LEGAL NON-CONFORMING STATUS - A legal non-conforming sign shall immediately lose its legal non-conforming status upon the occurrence of one or more of the events listed in this Zoning Ordinance, pursuant to state law, or when there is a change in:
  - a. The type of use or occupancy type on the property on which the sign is located;
  - b. The location, size, height, or type of sign; or
  - c. The amount of frontage such that the existing sign would not be permitted by this Ordinance.
  - d. A sign, being a structure, is also subject to the provisions of section 6.2.2 of this ordinance in regard to a prohibition of restoration after damage greater than 50% of its current replacement value.

## 22.2 - PROHIBITED SIGNS

The following signs are prohibited in the City of Foley, and no permits for the construction of these signs will be issued, and all existing signs of this nature that are now in the corporate limits of the City of Foley or may hereafter come into the corporate limits of the City of Foley will either be classified as legal non-conforming or unlawful.

- A. Billboards, provided, however, the Planning Commission may, as part of its approval of the Master Signage Plan (MSP) for a PUD, PDD, or PID, grant one or more lots in the development the option to locate their ground sign(s) in specifically defined locations in a common area of that same PUD, PDD, or PID.
- B. Signs located in public areas or right-of-ways. With the exception of: Signs erected by or on behalf of the governmental entity responsible for maintenance and repair of said right-of-way, including signs posting legal notices, identifying public property, conveying public information, and signs directing or regulating pedestrian or vehicular traffic to businesses or other locations; bus stop signs erected by a public transit company; informational signs of a public utility regarding its poles, lines, pipes, or facilities; and awnings, projecting and suspended signs which conform to the conditions of these regulations.
- C. Vehicle Signs: except those vehicles used in normal day-to-day operations of the business. Vehicles parked for more than three (3) consecutive days are not considered regularly used in the conduct of normal day-to-day business. Vehicle signs used in normal day-to-day business shall be parked to the rear or side of businesses when possible. When rear and side parking is not possible vehicles shall be parked at a minimum of 100 feet from all highways and expressways. No vehicle signs shall be parked in the City right-of-way, unless the business has no other parking areas on premise.
- D. Portable Signs: A moveable sign that is not permanently attached to either the ground or a structure, or a sign designed to be transported, including, but not limited to, signs designed to be transported by means of wheels; sign converted to A- or T- frames; menu and sandwich board signs; feather flags; pennants; handheld signs; caricature signs; inflatable's; umbrellas (used for advertising), except those permitted as Special Event Signs in 22.4 EXEMPT PERMIT SIGNS or those which may be allowed in an applicable Overlay District.
- E. Roof top signs.
- F. Beacons and Revolving signs.
- G. Flashing signs, traveling lights or intensely lighted signs.



### 22.3 - TEMPORARY SIGNS NOT REQUIRING PERMITS

The following temporary signs are allowed with the following conditions, and do not require a permit. This section specifically excludes Special Event Signs/Displays as described in 22.4 EXEMPT PERMIT SIGNS.

- A. Temporary signs shall not be illuminated.
- B. Drives or events of a civic, educational or religious nature are allowed to advertise for a period of two (2) weeks provided that:
  1. The sign is non-electric.
  2. The sign face must be less than thirty-two (32) square feet.
  3. They may be located on and/or off premise, provided it is not in the public right-of-way nor causing a traffic hazard (see 22.1 D - Visibility).
- C. New businesses in the City are allowed to advertise with a single sign for a period of (2) weeks provided that:
  1. The sign is non-electric.
  2. The sign face must not exceed thirty-two (32) square feet.
  3. The sign is located on premises and is not located in the public right-of-way nor causing a traffic hazard (see 22.1.D - Visibility).
- D. Real Estate Signs:
  1. Real Estate "For Sale" or Rental Signs (Residential):
    - a. Two (2) signs per property advertising the sale or rental are allowed on-premise and two (2) signs are allowed off-premise.
    - b. Must not exceed four (4) square feet of copy area per sign.
    - c. Such signs shall not be permitted for a period longer than thirty (30) days after closing the sale or rental of the property.
  2. On-Premise Real Estate "For Sale" or "For Rent" Signs (Commercial):
    - a. One (1) real estate "For Sale" or "For Rent" sign for commercially zoned properties is allowed for properties with up to 500 linear feet of frontage. An additional sign is allowed for each additional 500 feet of frontage.
    - b. Must be located entirely within the property.
    - c. Must not exceed thirty-two (32) square feet of copy area per sign.
    - d. Such sign(s) shall be removed within thirty (30) days of closing the sale or rental of the property.
  3. Off-Premise Real Estate "For Sale" or "For Rent Signs (Commercial):
    - a. One (1) sign advertising the selling or rental of such property is permitted
    - b. Must not exceed four (4) square feet of copy area.
    - c. Such sign shall be removed within thirty (30) days of closing the sale or rental of the property.
  4. Construction Signs:
    - a. Must not exceed thirty-two (32) square feet of sign face.
    - b. May be placed no sooner than actual demolition or construction activities begin and may continue until the permanent sign is erected or the certificate of occupancy is issued, whichever comes sooner.
    - c. Such sign shall not be located in the public right-of-way nor cause a traffic hazard (see 22.1.D - Visibility).
  5. Model Homes:
    - a. Temporary A-frame signs shall be allowed in residential zones only to be located on the lot of the model home during the business hours in which an agent(s) is present.
- E. Campaign or Election Signs are exempt provided that:

1. Signs advocating or opposing a public office or a position on an issue to be determined at an election shall not exceed twelve (12) square feet in residential districts. In all other zoned districts, signs shall not exceed thirty-two (32) square feet.
  2. Signs advocating or opposing a public office or position on an issue to be determined at an election shall be removed within ten (10) days after the election for which they were erected. In the event of a runoff election, signs may be displayed until the runoff election and then shall be removed within ten (10) days of the runoff election.
  3. Property owners shall be held responsible for violations of campaign and election signs.
  4. No signs shall be allowed in the public right-of-way, project into or overhang any right-of-way or be attached to any utility pole within the right-of-way.
- F. Decorative Displays
1. Single balloons under twenty-four (24) inches in circumference that do not contain copy are considered decorative.
  2. Flags that display seasonal, holiday, governmental and political displays are considered decorative.

#### **22.4 - TEMPORARY SIGNS REQUIRING AN EXEMPT PERMIT**

Temporary special use or event signs and displays are allowed but only under the following conditions and requirements:

- A. Special event signage and displays require an Exempt Permit (no fee required) found in the City's online permitting system under Planning & Zoning - Special Event Signs/Displays prior to the erection and placement of any such temporary sign or display. Such signs and displays shall be specifically described in writing as to their type and reason for special event.
  - a. Signs shall not exceed five (5) feet in height except for portable billboards.
  - b. Such signs shall not be illuminated.
  - c. For all lots containing multiple businesses, the property owner shall be responsible for all signage placed on the property, regardless of who erects the sign.
  - d. All such signs shall not be placed within ten (10) feet of the street right-of-way or in any other way as to obstruct the view of motorists or pedestrians.
  - e. An individual business shall be allowed a maximum of six (6) special event sign permits per calendar year, each of which shall be valid for four (4) consecutive days starting from the date of registration issuance or as noted on the registration.
- B. The following types of signs/displays which attract attention to a particular business may be registered as special event signs/displays:



SPECIAL EVENT SIGN / DISPLAY		
Sign Type	Quantity Allowed	Max Size Allowed
Balloons & Inflatables	1	20 ft in height from grade
Feather Flags	2	20 ft in height from grade
Pennants	2	???
Hand-held signs	1	6 sf sign face
Caricature signs	???	???
A or T frame signs	1	12 sf sign face
Menu/Sandwich Boards	1	12 sf sign face
Umbrellas	???	8 ft diameter
Banners	1	42-sf 30 sf sign face
Plastic/wire frame signs	1	12 sf sign face
Flags (not otherwise exempt)	1	15 sf
Portable Billboards	1	10'x13' or 130 sf

## 22.5 - SIGNS REQUIRING A PERMIT

A. **PLANNED DISTRICT SIGNAGE** - A Master Signage Plan (MSP) is designed to benefit the community in administering its sign regulations within a planned development and is required for the following zoning designations: Planned Unit Development (PUD), Planned Development District (PDD), and Planned Industrial District (PID). The Planning Commission will review the location, size, and other information to approve ground signs in common areas advertising specific businesses within a development. The Planning Commission may also review and approve any unique requests for other signage in these zones. The required information includes:

1. An accurate plot plan of the Development at a legible scale;
2. Location of signage for common areas, buildings, parking lots, driveways, amenities, landscaped areas and others;
3. An accurate indication of the proposed location of each present and future sign.
4. Size of the total Sign Face Area, the area of each individual sign, the height of the signs, an outline of the Sign Structure, and any electronic signage being requested.
5. A detailed description of any relaxation or exception that is being requested from the sizes shown in the following charts.
6. Documentation of who will be responsible for the maintenance and upkeep of the ground signs.

## B. RESIDENTIAL SIGNAGE

1. The following Zones are considered "residential" for the purposes of these sign regulations: R-1R, R-1A, R-1B, R-1C, R-1D, R-2, R-3, R-4, GPH-1, TH-1, MH-1, RV Park, and residential areas of a PUD, PDD, or AO



RESIDENTIAL SIGNAGE ALLOWED								
Purpose	Sign Type	Max Area per Face	# Faces	Max Height	Illumination	Setback	Number Signs	Electronic allowed?
Primary Entrance Neighborhood Identification	Ground	50 sf	2	6 ft	Direct or Indirect		1 at Main entrance	no
Secondary Entrance Neighborhood Identification	Ground	32 sf	2	5-4 ft	Direct or Indirect	25 ft	1 per Secondary entrance	no
Home Occupation	Ground	4 sf	2	4 ft	PROHIBITED		1	no
Bed & Breakfast	Ground	4 sf	2	4 ft	Direct or Indirect		1 containing only name, street address, and occupancy info	no

### C. COMMERCIAL/INDUSTRIAL SIGNAGE

- The following Zones are considered "commercial/industrial use" for the purposes of these sign regulations: B-1, B-1A, B-2, B-3, M-1, Commercial & Industrial areas of a PUD or PDD
- Painted Murals on the sides of buildings are allowed and are not considered to be a sign unless copy is included which advertises a business or service. If copy is included, this is a sign and must comply with this ordinance.
- If a business does not have a ground sign, the wall sign may be increased by the square footage of the allowed ground sign.
- Signs for free standing single tenant retail establishments in excess of 100,001 sf may increase by 10% for each additional 100,000 sf.
- Based on street frontage, the total sign face area (wall & ground) as determined by following Commercial charts below may be increased as follows:

SIGN FACE AREA BY STREET FRONTAGE					
FRONTAGE	200-400 ft	401-600 ft	601-800 ft	801-1000 ft	>1000 ft
Increase to Sign Face Area	10%	20%	30%	40%	50%

- The square footage of structures listed in the Purpose column of the chart below refers to the footprint of the ground foundation.



**COMMERCIAL/INDUSTRIAL SIGNAGE ALLOWED (excluding B-1)**

Purpose	Sign Type	Max Area per Face	# Faces	Max Height	Illumination	Number Signs	Electronic allowed?
Free standing Single Tenant Structures <2,900 sf	Wall	80 sf	1	not to exceed highest roofline	Internal	1 per Facing Street/ Driveway	Yes, except Historic.
	Ground	120 sf	2	20 ft	Internal	1 per 500 ft of frontage	Yes, except Historic.
Free standing Single Tenant Structures 2,901 - 15,000 sf	Wall	80 sf	1	not to exceed highest roofline	Internal	1 per Facing Street/ Driveway	Yes, except Historic.
	Ground	160 sf	2	25 ft	Internal	1 per 500 ft of frontage	Yes, except Historic.
Free standing Single Tenant Structures 15,001 - 30,000 sf	Wall	200 sf	1	not to exceed highest roofline	Internal	1 per Facing Street/ Driveway	Yes, except Historic.
	Ground	200 sf	2	25 ft	Internal	1 per 500 ft of frontage	Yes, except Historic.
Free standing Single Tenant Structures 30,001 - 50,000 sf	Wall	200 sf	1	not to exceed highest roofline	Internal	1 per Facing Street/ Driveway	Yes, except Historic.
	Ground	210 sf	2	25 ft	Internal	1 per 500 ft of frontage	Yes, except Historic.
Free standing Single Tenant Structures 50,001 - 100,000 sf	Wall	220 sf	1	not to exceed highest roofline	Internal	1 per Facing Street/ Driveway	Yes, except Historic.
	Ground	220 sf	2	30 ft	Internal	1 per 500 ft of frontage	Yes, except Historic.
Building Front signs for Establishments in Multi-tenant Buildings (only allowed if store has frontage)	Wall or Projecting	Not covering more than 30% of store frontage	W: 1 P: 2	not to exceed roofline	Internal	1 per Facing Street/ Driveway	Yes, except Historic.
Multi-tenant Locator Signs ≤ 10,000 sf	Ground	100 sf ***	2	25 ft	Internal	1	Yes, except Historic.
Multi-tenant Locator Signs 10,001 - 30,000 sf	Ground	150 sf ***	2	30 ft	Internal	1 per Facing Street, total sign face area of all locator signs not to exceed 200 sf	Yes, except Historic.
Multi-tenant Locator Signs ≥ 30,001 sf	Ground	300 sf ***	2	35 ft	Internal	1 per Facing Street, total sign face area of all locator signs not to exceed 400 sf	Yes, except Historic.
Parking Lot Identification	Ground	32 sf	2	5 ft	Non-oscillating, concealed light source. (spotlight or floodlight prohibited)	1 per entrance	No



B-1 COMMERCIAL SIGNAGE ALLOWED							
Purpose	Sign Type	Max Area per Face	# Faces	Max Height	Illumination	Number Signs	Electronic allowed?
Business Identification	Ground	32 sf	2	5 ft	Direct, Indirect, or Internal	1 per facing street	no
Business Identification	Wall or Projecting	40 sf max - may not exceed 30% of the buildings frontage	W: 1 P: 2	W: 20 ft, or at Roofline, whichever is lower P: Min 9 ft above sidewalk	Direct, Indirect, or Internal	1 per facing street / driveway	no
Multi tenant Business Identification	Wall or Projecting	2 sf	1	W: 20 ft, or at Roofline, whichever is lower P: Min 9 ft above sidewalk	n/a	1 per tenant at the entrance of each tenants space	no
Parking Lot Identification	Ground	32 sf	2	5 ft	Non- oscillating, concealed light source. (spotlight or floodlight prohibited)	1 per entrance	no

#### D. OFFICE SIGNAGE

- The following Zones are considered "office use" for the purposes of these sign regulations: PO, and Office areas of a PUD or PDD

OFFICE SIGNAGE ALLOWED							
Purpose	Sign Type	Max Area per Face	# Faces	Max Height	Illumination	Number Signs	Electronic allowed?
Office Buildings ≤ 10,000 sf floor area	Ground	32 sf	2	5 ft	Direct, Indirect, or Internal	1 per Facing Street	no
Office Buildings ≤ 10,000 sf floor area	Wall or Projecting	32 sf	W: 1 P: 2	12 ft	Direct, Indirect, or Internal	1 per Facing Street/Driveway	no
Office Buildings ≥ 10,001 sf floor area	Ground	50 sf	2	9 ft	Direct, Indirect, or Internal	1 per Facing Street	no
Office Buildings ≥ 10,001 sf floor area	Wall or Projecting	32 sf	W: 1 P: 2	20 ft, or at Roofline, whichever is lower	Direct, Indirect, or Internal	1 per Facing Street/Driveway	no
Parking Lot Identification	Ground	32 sf	2	5 ft	Non- oscillating, concealed light source. (spotlight or floodlight prohibited)	1 per entrance to parking lot	no



## E. OTHER SIGNAGE

OTHER SIGNAGE ALLOWED									
Zone	Purpose	Sign Type	Max Area per Face	# Faces	Max Height	Illumination	Setback	Number Signs	Electronic allowed?
OA	Identification	Ground	200 sf	2	25 ft	Indirect / Internal	25 ft	1 per entrance	yes
	Promotional/Sponsorship materials within Park boundaries are exempt from the Sign Regulations								

### 22.6 - ELECTRONIC SIGN REGULATIONS

Electronic changeable copy (ECC) signs may be permitted as a detached freestanding or attached flat sign as follows:

- A. Not allowed in the City of Foley Historic Overlay District, regardless of zone.
- B. Allowed in zones: B1A, Extended Business District; B2, Neighborhood Business District; B3, Local Business District; M1, Light Industrial District; and Open Space/Preservation District.
- C. Allowed in the commercial or industrial portions of a Planned Zone (PID, Planned Industrial District; PUD, Planned Unit Development; or PDD, Planned Development District), when specifically included as a part of a Master Signage Plan (see section 22.5.D.1).
- D. The signs must meet all size and Vision Clearance Area requirements for the zoning and/or overlay district in which they are located.
- E. May not display messages that do not pertain to business conducted on the premises on which the sign is located, unless otherwise exempted or a public service announcement.
- F. Display of any message must be static. There shall be no effects of movement, flashing, scintillation, or similar effects in the individual images.
- G. DETACHED FREESTANDING ELECTRONIC SIGN REQUIREMENTS
  - a. The ECC sign must be located on the site of the use identified or advertised by the sign.
  - b. No more than one (1) ECC sign with a maximum of two (2) parallel sides is permitted per lot of record.
  - c. Lots with multiple businesses shall be allowed one (1) detached freestanding ECC sign to service all businesses located on that lot.
  - d. ECC signs may not display colors, words, or images that interfere with or mimic a traffic control signal or device. (ie. - "STOP", "GO", "DANGER", etc.).
  - e. Sign display technology shall be programmed so that the message or image on the sign changes ~~Electronic changeable copy signs shall change~~ no more than one (1) time per ten (10) seconds.
  - f. Changes of image shall be substantially instantaneous as seen by the human eye and shall not use fading, rolling, window shading, flashing, spinning, rotating, dissolving, or similar effects as part of the change.
  - g. Detached ~~electronic changeable copy~~ ECC signs must form an integrated portion of an on-premises detached sign. The electronic changeable copy portion of the detached sign may be separated from the remainder of the sign. If the electronic message center portion of the sign is being utilized after sunset, the existing static portion of the sign must be functioning, illuminated, and readable.



- h. The area of the ~~electronic changeable copy~~ ECC sign may comprise no more than fifty percent (50%) of the surface area of the allowable detached sign of which it is a part. Neither shall any portion of the ~~electronic changeable copy~~ ECC sign project above the height of the permanent detached signage. ~~Electronic changeable copy signs~~ ECC message centers are secondary to the permanent non-changeable portions of the sign and should be ~~designated~~ designed in this regard.
- i. An ~~electronic changeable copy~~ ECC sign shall be included in the calculation of the total permitted sign area of the detached sign of which it is a part.
- ~~j. The sign must have a light sensing/dimming device to control the maximum light intensity. The sign should be dimmed down 90% to a minimum 10% brightness at night. Electronic changeable copy signs must have an automatic dimmer control to produce a distinct illumination change from a higher illumination level to a lower level (10% of max brightness) for the time period between one-half hour before sunset and one-half hour after sunrise. In addition, it must also be able to respond to lighting level changes occurring due to atmospheric conditions.~~
- k. ~~Electronic changeable copy signs located within any residential district are allowed only for neighborhood identification signs and bed and breakfasts, as permitted by special exception. The leading edge of an electronic changeable copy ECC sign located in any district must be a minimum distance of one hundred (100) feet from an abutting occupied single-family residential district boundary. An electronic changeable copy ECC sign may not face an abutting residential district.~~
- l. ~~Electronic changeable copy~~ ECC signs must be separated from other ~~electronic changeable copy~~ ECC signs by at least fifty (50) feet.
- m. All ~~electronic changeable copy~~ ECC signs will be maintained in proper working order.
  - i. ~~If at any time the programming or technology that controls the brightness, time/date on message, or any other required visual display characteristic fails or malfunctions and is determined to be a hazard to the safety of the traveling public, the sign shall be immediately turned off, disconnected or disabled.~~
  - ii. Any dead zones or non-illuminated portions of the signs shall be replaced or repaired within fourteen (14) working days, or as soon as possible conditions allowing, or the use of the sign shall be discontinued.
- n. If at any time subsequent to the adoption of this Section of the Zoning Ordinance any portion of these regulations is deemed to be a safety hazard by the City of Foley, the City reserves the right to modify said regulations and all existing signs shall be modified to conform to the safety-related modifications.

#### H. ATTACHED FLAT ELECTRONIC SIGN REQUIREMENTS

- a. A maximum of one (1) ~~single sided attached~~ ECC wall sign is permitted for a site that does not contain any other ~~electronic changeable copy~~ ECC sign, detached or wall mounted.
- b. Such signs may not exceed thirty-two (32) square feet in area and will be counted toward the calculation for maximum signage for the building and must comply with all other applicable provisions of this ordinance.
- c. Wall mounted signs shall not be oriented toward adjacent residential uses.

#### 22.7 - SIGNS LOCATED IN OVERLAY DISTRICTS

If a property is located within an overlay district, that Overlay District's specific signage rules and relaxations will override the rules stated within Article XXII in the event of a conflict.



# Proposed Amendments to Zoning Ordinance - Site Plans

Prepared by Eden Lapham, PC May 2024

## ARTICLE XI - SITE PLAN REVIEW

### 11.1 SITE PLAN REVIEW

Site plans may be required to be submitted to the Planning Commission for input in cases where the proposed development meets the following criteria. The site plan approval will be valid for 12 months but will expire after this date if no **building** permits have been obtained. The Planning Commission may ~~extend the site plan approval if it is determined there is an extenuating circumstance~~ **grant one 1-year extension if no city regulations have been amended that would affect the site.**

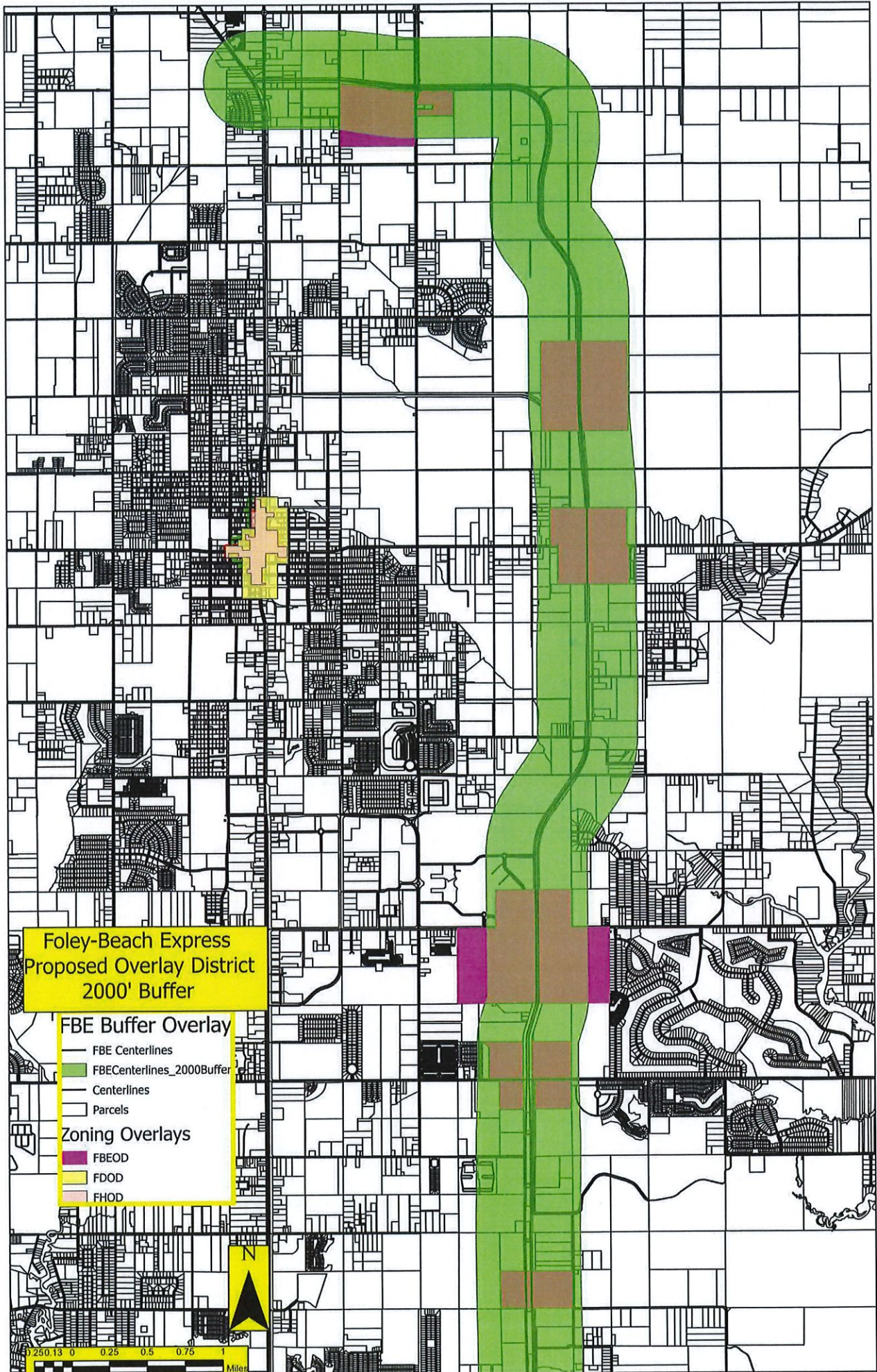



ORDINANCE 24-\_\_\_\_\_

AMENDING THE CITY OF FOLEY ZONING ORDINANCE

WHEREAS, the City of Foley, Alabama, adopted Ordinance No. 387-87 on June 15, 1987, ordaining a new Zoning Ordinance and Zoning Map for the City of Foley which has subsequently been amended, and

WHEREAS, the City of Foley Planning Commission has recommended changes within the current Zoning Ordinance, and the City Council of the City of Foley deems it necessary, for the purpose of promoting the health, safety, morals and general welfare of the City to amend said Ordinance, and

WHEREAS, all requirements to the laws of the State of Alabama, with regard to the preparation of the report of the Foley Planning Commission and subsequent action of the City Council have been met,

NOW, THEREFORE, BE IT ORDAINED BY THE CITY COUNCIL OF THE CITY OF FOLEY, ALABAMA while in regular session accepted the following changes:

Zoning Ordinance Amendments:

## **ARTICLE II - DEFINITIONS**

### **2.1 DEFINITIONS APPLICABLE TO THIS ORDINANCE**

Dumpster Enclosure. Dumpster / Trash enclosures are a structure built to provide shelter for a trash dumpster and for recyclable materials.

Landscaping Material. Living material including, but not limited to, trees, shrubs, vines, lawn grass, ground cover, and landscape water features. Non-living material may be used in such a manner as to present a finished appearance and to complete coverage, and may consist of pine or cypress bark, crushed pecan shell, pine straw, or other decorative mulch.

Master Signage Plan (MSP): A comprehensive document presented to and approved by the Planning Commission that contains a set of criteria and standards for present and future freestanding signage in common areas of a Planned Development in order to create a cohesive architectural statement. The MSP should identify locations of all expected signage and call out any requested relaxations of the standard sign regulations included in this zoning ordinance. The MSP may be modified as needed during site plan approvals through a Planned Development's progress in phases.

~~Nit: A term used to describe a unit of measure for luminance intensity per unit area that is projected in a given direction. A nit is equal to one candela per square meter. A nit measures the luminance of a light source which is closely related to the perceived "brightness" of the light source.~~

Open Space: Land which is landscaped or left in a natural state and is intended for natural or scenic preservation and/or active / passive recreational uses and their accessory Structures. Where minimum Open Space reservation percentages of a development are required per the Zoning Ordinance, the percentage amount and use restrictions are detailed in the individual zone. The City's Land Development Ordinance also contains "Conservation Area" or "Green Space" requirements that must be met in conjunction with the Zoning Ordinance Open Space requirements.

~~Parking Space: The space necessary to park an automobile which shall not be less than an area ten (10) feet wide by twenty (20) feet long for perpendicular parking spaces and nine (9) feet by twenty (20) feet for a herringbone/angle design. All parking spaces required shall be provided along with necessary lanes and maneuvering areas. Size requirements are defined in Article 10. No two-way entrance or aisle shall be less than twenty five (25) feet in width. In no event shall an entrance or aisle be less than twenty (20) feet.~~

Planned Developments: Planned Developments include ~~Townhomes, Multi-Family and Mixed Use developments~~ R3 Residential Multi-Family, TH-1 Residential Townhouse, PUD Planned Unit Development, PDD Planned Development District, MH-1 Mobile/Manufactured Dwelling Parks, RV Recreational Vehicle Parks and PID Planning Industrial Districts.. These zones require a master plan layout prior to zoning / rezoning. The approved layouts then become the "zoning" for these properties and are considered site plan approval as well unless otherwise noted in the meeting minutes. The approved layouts can only be modified by the Planning Commission and in certain instances will require City Council approval as well.

Sign, Changeable Copy: A sign upon which the copy may be manually changed, rearranged, or altered or removed without altering the structure of the sign face or support.

Site Plan: The plan drawings of a proposed development on a lot or lots which reflects the existing conditions and proposed changes, including drainage, and any other possible environmental impact.

Sign, Monument: A sign mounted to the ground and designed with a continuous structural element of approximately the same dimension from the ground to the top of the sign.

~~Storage Structures / Open Space-Storage: A structure, groups of structures or open space intended, designed, or capable of being used as rental storage facilities to individuals, businesses or other entities. Said definition shall also include the term "mini-warehouse", "boat", "RV" and other similar storage facility-facilities.~~

## **ARTICLE III - PURPOSE AND METHOD**

### **3.3 ZONING DISTRICT Classification Chart**



Designation	General Use	Specific Use
R-1R	Residential Zone	Restricted Single Family
R-1A	Residential Zone	Single Family
R-1B	Residential Zone	Single Family
R-1C	Residential Zone	Single Family
R-1D	Residential Zone	Single Family
R-2	Residential Zone	Single Family & Two Family
R-3	Residential Zone	Multi-Family
R-4	Residential Zone	Single Family & Two Family
GPH-1	Residential Zone	Garden-Patio Homes
TH-1	Residential Zone	Townhouses
MH-1	Residential Zone	Mobile Home/Park Subdivision
RV	Special Use	RV Park - short term rentals
PUD	Special Use	Planned Unit Development
PDD	Special Use	Planned Development District
PID	Industrial Use	Planned Industrial District
B-1	Commercial Use	Central Business District
B-1A	Commercial Use	Extended Business District
B-2	Commercial Use	Neighborhood Business District

Designation	General Use	Specific Use
B-3	Commercial Use	Local Business District
PO	Office Zone	Preferred Office District
M-1	Industrial Zone	Light Industry
A-O	Agriculture	Open Space / Agricultural Use
OSP	Parks/Public Land	Open Space / Preservation District
PUBLIC USE	Government/Public Use	Parks and Buildings for Public Use
H	Historic Overlay	Overlying Area of Historic District
FDOD	Foley Downtown	Overlay of Downtown

## ARTICLE IX - COMMERCIAL – MISCELLANEOUS

Dumpster / Trash Enclosures are considered accessory structures for setback, location and similar purposes. Please refer to Engineering / Public Works for specific design criteria.

## ARTICLE XIII - DISTRICT REGULATIONS

### 13.1.1 USES / STRUCTURES PERMITTED

Unless specifically prohibited in a particular zoning district, the following uses and structures are permitted by right in all districts.

A. Public utilities, excluding electric and gas substations and water / wastewater pumping stations;

## ARTICLE X - PARKING, LANDSCAPING, BUFFER, & LIGHTING REQUIREMENTS

10.1.D.7. Warehouses, Storage Structures / Open Space Storage – 1 space for each 3,000 sq. ft. of gross floor area.

10.1.E Parking space and aisle size requirements:



1. Perpendicular spaces - 10 ft wide by 20 ft long
2. Herringbone/Angle spaces - 9 ft wide by 20 ft long
3. One way traffic parking lot aisle width - 20 ft minimum
4. Two way traffic parking lot aisle width - 25 ft minimum

#### **10.1.1.USE AND MAINTENANCE OF PARKING LOTS (NON-RESIDENTIAL)**

Off-street parking for non-residential uses:

- A. Required parking must be designated by pavement, gravel, cross-ties or some similar method.
- B. Shall not be used for the parking or storage of automobile trailers, boat trailers, non-motorized recreational vehicles and similar vehicles.

#### **10.3 Exterior Lighting Requirements**

- A. Purpose and Intent: The purpose of this regulation is to minimize light pollution, glare, and light trespass by establishing guidelines for exterior lighting applications. These regulations aim to ensure that outdoor lighting enhances safety and visibility while minimizing adverse impacts on the night sky and neighboring properties.
- B. Application Requirements:
  1. Exterior lighting plans are required for all projects other than single family residential. An exterior lighting plan, including a photometric plan (which covers the parcel which is the site of the building or project in question), appropriate pole, fixture, and lamp cut sheets, and descriptions of lenses and appropriate data tables, shall be submitted for review during the site plan approval process.
  2. All applications for exterior lighting installations must include the following:
    - a. Photometric Plans: A detailed photometric plan covering the entire site must be submitted. The plan should demonstrate the distribution of light and ensure compliance with the requirements outlined in this regulation. Photometric plans must be prepared by a licensed professional engineer or lighting designer.
    - b. Fixture Specifications: Complete specifications for all lighting fixtures proposed for installation, including cut sheets, must be provided. This should include information on the fixture type, wattage, shielding, and any additional features designed to minimize light pollution, glare, or spill light.
    - c. Mounting Heights: Proposed mounting heights for lighting fixtures should be specified, ensuring that fixtures are positioned to minimize upward light and glare.
    - d. Control Measures: Applicants must outline any proposed control measures, such as timers, motion sensors, or dimmers, intended to minimize unnecessary or excessive lighting during non-operational hours.
- C. Photometric Performance Requirements:

1. Light Distribution: Lighting fixtures must be selected and positioned to achieve uniform light distribution across the site, with emphasis on minimizing upward light and spill light onto adjacent properties.
  2. Cutoff Fixtures: All lighting fixtures must be cutoff fixtures, designed to limit upward light emissions and glare.
  3. Spill Light Control: Measures must be implemented to minimize spill light onto adjacent properties. This may include the use of shields, baffles, or other appropriate methods to direct light downward and confine it within the boundaries of the property.
- D. Illumination Levels:
1. Maximum Intensity: The maximum illumination levels at the property line should not exceed 0.5 footcandles when adjacent to residential properties and 1.0 footcandles when adjacent to other uses. These levels should be maintained throughout the operational hours of the lighting system.
  2. Gradual Dimming: Lighting systems must incorporate gradual dimming controls to reduce illumination levels during non-operational hours, minimizing light pollution and unnecessary energy consumption.
- E. Prohibitions: The installation, retrofitting, or modification of wall pack lighting fixtures, as well as any similar fixtures attached to exterior walls and characterized by outward-facing design and emitting excessive glare and spill light, is strictly prohibited.
- F. Compliance and Enforcement:
1. Inspections: Compliance with this regulation will be verified through site inspections conducted by authorized personnel.
  2. Penalties: Non-compliance with the requirements of this regulation may result in penalties, including fines and the requirement to modify or remove non-compliant lighting installations.
- G. Exemptions: While the following are exempt from certain provisions of this regulation but must still adhere to the principles of minimizing light pollution, glare, and light trespass to the greatest extent possible.
1. Emergency lighting necessary for safety and security purposes is exempt from certain provisions of this regulation but must still adhere to the principles of minimizing light pollution, glare, and light trespass to the greatest extent possible.
  2. Exemptions from the provisions of this ordinance are permitted when federal or state laws, rules, and regulations take precedence over these provisions.
  3. Public schools.
  4. Recreational sporting venues owned by the City
- H. Applicability: This regulation applies to all new exterior lighting installations and modifications to existing installations within the City.
- I. Definitions:
1. Photometric Plans: Detailed diagrams illustrating the distribution and intensity of light across a site, typically prepared by a licensed professional engineer or lighting designer. These plans provide critical information for assessing the performance of exterior lighting installations and ensuring compliance with regulatory standards.



2. Footcandle (f.c.): A unit of illuminance measuring one lumen per square foot.
3. Control Measures: Strategies and mechanisms implemented to regulate the operation of lighting systems, including timers, motion sensors, dimmers, and other devices intended to minimize unnecessary or excessive lighting during non-operational hours.
4. Light Distribution: The manner in which light is spread or dispersed across a given area, aiming to achieve uniform illumination while minimizing glare, hot spots, and uneven lighting. Proper light distribution is essential for optimizing visibility and safety in outdoor environments.
5. Cutoff Fixtures: Outdoor lighting fixtures designed to limit the upward emission of light and control glare by utilizing shielding or other mechanisms to direct light downward. Cutoff fixtures help minimize light pollution and prevent unnecessary illumination of the night sky.
6. Spill Light Control: Measures implemented to minimize the unintended projection of light beyond the boundaries of a property, reducing light trespass onto adjacent properties and minimizing the adverse effects of glare and excessive illumination.
7. Maximum Intensity: The maximum allowable level of illumination at the property line, typically expressed in footcandles (fc). Maximum intensity standards help ensure that lighting installations do not produce excessive glare or spill light onto neighboring properties, contributing to a more visually comfortable and environmentally responsible outdoor lighting environment.
8. Gradual Dimming: A feature of lighting systems that allows for the gradual reduction of illumination levels during non-operational hours. Gradual dimming controls help minimize light pollution, conserve energy, and promote responsible outdoor lighting practices by adjusting lighting levels to match changing environmental conditions and usage patterns.
9. Emergency Lighting: Lighting systems designed to provide illumination during emergency situations, such as power outages or evacuations, to ensure the safety and security of occupants. While emergency lighting is exempt from certain provisions of exterior lighting regulations, it is still subject to requirements aimed at minimizing light pollution, glare, and light trespass.
10. Wall pack lighting fixtures are defined as outdoor lighting fixtures designed to be attached directly to exterior walls, characterized by their outward-facing design and tendency to emit excessive glare and spill light.

## **ARTICLE XI - SITE PLAN REVIEW**

Site plans may be required to be submitted to the Planning Commission for input in cases where the proposed development meets the following criteria. Please note that site plan criteria for planned developments falls under a different category - see Definition. The site plan approval will be valid for 12 months but will expire after this date if no building development / building permits have been obtained. The Planning Commission may extend the site plan approval if ~~it is determined there is an extenuating circumstance.~~ engineering & environmental permits are in process or if a portion of the building permits

have been pulled for the project. A new site plan meeting the most current regulations may be submitted for Planning Commission review & consideration.

## **ARTICLE XIV - SINGLE FAMILY RESIDENTIAL & DUPLEX DISTRICTS**

### **14.1.1 R-1R RESTRICTED RESIDENTIAL SINGLE FAMILY**

D. Requirements:

Garage Setback (Front Loaded)	40'
-------------------------------	-----

### **14.1.2 R-1A RESIDENTIAL SINGLE FAMILY**

D. Requirements:

Garage Setback (Front Loaded)	40'
-------------------------------	-----

### **14.1.3 R-1B RESIDENTIAL SINGLE FAMILY**

D. Requirements:

Garage Setback (Front Loaded)	40'
-------------------------------	-----

### **14.1.4 R-1C RESIDENTIAL SINGLE FAMILY**

D. Requirements:

Garage Setback (Front Loaded)	40'
-------------------------------	-----

### **14.1.5 R-1D RESIDENTIAL SINGLE FAMILY**

D. Requirements:

Garage Setback (Front Loaded)	40'
-------------------------------	-----

### **14.1.6 R-2 RESIDENTIAL SINGLE FAMILY AND DUPLEX**

D. Requirements:

SINGLE FAMILY:

Garage Setback (Front Loaded)	40'
-------------------------------	-----

DUPLEX:

Minimum Lot Area (duplex)	11,500 square feet*
---------------------------	---------------------

Landscape Requirements (duplex)	10% of Minimum lot area
---------------------------------	-------------------------

Garage Setback (Front Loaded)	40'
-------------------------------	-----



DEFINITIONS:

- i. Architectural Details - Include but are not limited to: porch railings; column size, taper, base and molding; dormer windows; shutters; ~~transparency~~; and similar.
- ii. Building Facade Recesses - Porches or patios
- iii. Landscaping - ~~An area of mixed vegetation along the primary facade facing the street. Landscaping can consist of trees and/or shrubs.~~ See Definition of "Landscaping Material".

**14.1.7 R-4 RESIDENTIAL SINGLE FAMILY AND DUPLEX**

D. Requirements:

SINGLE FAMILY:

Garage Setback (Front Loaded)	40'
-------------------------------	-----

DUPLEX:

Minimum Lot Area (duplex)	11,500 square feet*
Landscape Requirements (duplex)	10% of Minimum lot area
Garage Setback (Front Loaded)	40'

DEFINITIONS:

- iv. Architectural Details - Include but are not limited to: porch railings; column size, taper, base and molding; dormer windows; shutters; ~~transparency~~; and similar.
- v. Building Facade Recesses - Porches or patios
- vi. Landscaping - ~~An area of mixed vegetation along the primary facade facing the street. Landscaping can consist of trees and/or shrubs.~~ See Definition for "Landscaping Material".

**14.1.8 GPH-1 RESIDENTIAL GARDEN PATIO HOMES**

D. Requirements:

Garage Setback (Front Loaded)	40'
-------------------------------	-----

**ARTICLE XVI - MANUFACTURED HOMES**

**16.1.3.C Required Open Space:**

1. Each mobile / manufactured dwellings park shall provide land for open space which may be used for recreational purposes, but which may not be used for parking or for accessory

structures. Such open space shall total at least fifteen percent (15%) of the gross land area of the park. This requirement does not apply to mobile / manufactured dwellings subdivisions.

2. Mobile / manufactured dwellings subdivisions greater than five (5) acres in total area shall include, at a minimum, open space equal to ten percent (10%) of the total area. Such open space may be used for recreational purposes, but may not be used for parking or accessory structures.
3. The City's Land Development Ordinance also contains guidance and requirements for Conservation Green Space that must be met in conjunction with this Zoning Ordinance Open Space requirement.

## **ARTICLE XVII - RECREATIONAL VEHICLE (RV) PARK**

### **17.1.3 GENERAL REQUIREMENTS**

**17.3.D** Minimum 25% open space excluding required stormwater / drainage. The minimum 25% shall be reserved collectively in contiguous units accessible to all the RV sites and maintained by the property owners. This open space is to be used for: accessory uses, parks, recreation facilities, sidewalks, clubhouse, pool, and similar. The City's Land Development Ordinance also contains guidance and requirements for Conservation Green Space that must be met in conjunction with this Zoning Ordinance Open Space requirement.

## **ARTICLE XVIII - COMMERCIAL / OFFICE DISTRICTS**

**18.1.1.B** - Uses / Structures Permitted on Appeal: Automobile filling stations, motels, automobile repair (minor and major), large dry cleaners and laundries, veterinary clinics / hospitals, manufacturing incidental to a retail business where articles are sold at retail on the premises, other uses not specifically restricted herein; storage structures / open space storage; home based businesses; and home occupations.

**18.1.2.B** - Uses / Structures Permitted on Appeal: Automobile repair (major); large dry cleaners and laundries, veterinary clinics/hospitals, manufacturing incidental to a retail business where articles are sold at retail on the premises, other uses not specifically restricted herein; storage structures / open space storage.

**18.1.3.B** - Uses / Structures Permitted on Appeal: Large dry cleaners and laundries; veterinary clinics and hospitals; automobile repair (major), manufacturing incidental to a retail business where articles are sold at retail on the premises, wholesale businesses, storage structures / open space storage.

**18.1.4.B** - Uses / Structures Permitted on Appeal: Veterinary clinics / hospitals; kennels; wholesale; storage structures / open space storage.

## **ARTICLE XXI - PLANNED DEVELOPMENTS**



### 21.1.1.1 R-3 Residential Multi-Family

- **E.6.b** - Include sufficient open spaces in the form of squares, greens and parks. A minimum of 25% of open space shall be provided in all multiple family developments. Stormwater retention areas are not included in this 25% open space requirement, unless it is properly designed and determined to be acceptable open space by the Planning Commission. The City's Land Development Ordinance also contains guidance and requirements for Conservation Green Space that must be met in conjunction with this Zoning Ordinance Open Space requirement.

### 21.1.1.2 TH-1 Residential Townhouse

- D. Requirements:

Minimum Area	1 acre
Minimum Lot Area	2,400 square feet*
Minimum Lot Width at Building Line	25 24 feet
Minimum Depth of Front Yard	20 feet
Minimum Depth of Rear Yard	15 feet
Minimum Width of Side Yard (on end unit)	16 feet
Minimum Depth of Side Yard Abutting Street	16 feet
Minimum Open Space if <5 ac	20%
Minimum Open Space if ≥5 ac	25%
Maximum Building Height (feet):	50 feet
Maximum Building Height (stories):	3
Off-Street Parking Spaces (per family unit)	2
Maximum Density Per Acre	15

\* or meet Health Department requirements.

- H.9 - Townhouse developments with a total area less than five (5) acres shall have at least twenty (20) percent common open space and five (5) acres or greater shall have at least twenty-five (25) percent of the total area devoted to common open space, exclusive of parking areas, accessory buildings, or required drainage. Such common open areas may include recreational facilities. In addition, the developer of a townhouse development or homeowners association created by the developer by recorded covenants and restrictions, shall preserve for the owners

and occupants of the development such lands set aside for open areas, parks, or recreational use, and the common off-street parking spaces established for the development. The City's Land Development Ordinance also contains guidance and requirements for Conservation Green Space that must be met in conjunction with this Zoning Ordinance Open Space requirement.

#### **21.2.1 PUD - PLANNED UNIT DEVELOPMENT**

- **C.7 - Open Space Reservation:** Not less than 25% of the PUD site shall be reserved collectively in contiguous units accessible to all the building sites in the PUD and maintained by the property owners for open space for the purpose of providing parks, recreational facilities, ways for pedestrian movement and circulation, and for conserving visually pleasing elements of the environment. This open space does not include areas reserved for drainage purposes. If the PUD is developed in stages, the amount of open space reserved and developed for use in each stage will constitute no less than an equivalent proportional amount to the area being developed. The City's Land Development Ordinance also contains guidance and requirements for Conservation Green Space that must be met in conjunction with this Zoning Ordinance Open Space requirement.

#### **21.5 PDD – PLANNED DEVELOPMENT DISTRICT**

G. There shall be a minimum of at least twenty percent of the gross lot area (20%) designated open space in a PDD exclusive of all drives, walkways, parking areas and required drainage. Access roads and drainage infrastructure, water, sewer, electricity, telephone and other utilities shall be provided to serve the development at the completion of construction of each development phase. Performance bonds may not be posted for drainage and sewer work. The City's Land Development Ordinance also contains guidance and requirements for Conservation Green Space that must be met in conjunction with this Zoning Ordinance Open Space requirement.

## **ARTICLE XXV - OVERLAY DISTRICTS**

### **25.2 FOLEY ZONING MAP**

A layer defining the Historic Overlay District boundary will be provided in the online Foley Zoning Map. ~~The Foley Zoning Map shall be amended and shall reflect the designation of the Historic District Overlay according to the Historic District Overlay Boundaries and the letter H added as a suffix to the underlying zoning district(s).~~

### **25.8 ESTABLISHMENT OF FDOD BOUNDARIES**

A map of the FDOD overlay boundary is included in the Zoning Ordinance (see Appendix Exhibit A), and a layer containing the FDOD boundary will be provided in the online Foley Zoning Map. ~~The Foley Zoning Map shall reflect the designation of the Foley Downtown Overlay District according to the Foley~~



~~Downtown Overlay District Boundaries and the letters FDOD added as a suffix to the underlying zoning district(s).~~

## Proposed Amendments to ZO - Signs

### ARTICLE XXII - SIGN REGULATIONS

22.1 GENERAL PROVISIONS

22.2 PROHIBITED SIGNS

22.3 TEMPORARY SIGNS NOT REQUIRING PERMITS

22.4 TEMPORARY SIGNS REQUIRING AN EXEMPT PERMIT

22.5 SIGNS REQUIRING A PERMIT

22.6 ELECTRONIC SIGN REGULATIONS

22.7 SIGNS LOCATED IN OVERLAY DISTRICTS

### ARTICLE XXII - SIGN REGULATIONS

The purpose of these sign regulations are: to encourage the effective use of signs as a means of communication; to maintain and enhance the aesthetic environment and the city's ability to attract sources of economic development and growth; to improve pedestrian and traffic safety; to minimize the possible adverse effect of signs on nearby public and private property; and to enable the fair and consistent enforcement of these sign restrictions. This sign ordinance is adopted under the zoning authority of the city in furtherance of the more general purposes set forth in the Zoning Ordinance.

#### **22.1 - GENERAL PROVISIONS**

- A. PERMITS REQUIRED - Except as otherwise provided in this Ordinance, it shall be unlawful for any person to erect, construct, enlarge, move, alter or convert any sign in the City or cause the same to be done, without first obtaining a Building Permit for each sign from the Building Official.
  1. APPLICATION FOR PERMIT - The City's online application process shall be followed to request a sign permit. The following information is required to assure compliance with all appropriate laws and regulations of the City:
    - a. Name and address of owner of the sign.
    - b. Name and address of owner or the person in possession of the premises where the sign is located or to be located.
    - c. Clear and legible drawings with description definitely showing the location of the sign which is subject of the permit and all other existing signs for that particular business at that location. Signs located at intersections should also

provide required Vision Clearance Areas on the drawing as defined in section 22.1.D below.

- d. Drawings showing the dimensions, construction supports size, electrical wiring, components, illumination method, materials of the sign and method of support.
  - e. If the sign is or will be located within the Local Downtown Historic District, a Certificate of Appropriateness (COA) must be received prior to permit application.
2. DENIAL OF PERMIT - When a permit is denied by the Community Development Director, notice shall be given to the proper applicant with a written statement of the reason or reasons for the denial. Said statement shall be made as an attachment to the permit application.
  3. APPEAL OF PERMIT DENIAL - If the denial is based on the interpretation or enforcement of the Zoning Ordinance, any aggrieved party may appeal the decision or interpretation of the Community Development Director to the Zoning Board of Adjustment and Appeals.
  4. USES PERMITTED AND USES PERMITTED ON APPEAL - Signs allowed for Article XIII - District Regulations (Section 13.1.1 "Uses Permitted", and Section 13.1.2 - "Uses Permitted on Appeal") shall meet the requirements of the zoning district in which they are located.
  5. PERMIT EXCEPTIONS - The following activities shall not require a permit from the City of Foley, but the sign shall comply with the other provisions of this ordinance:
    - a. Altering the advertising copy or message on an existing approved sign or marquee which is specifically designed for the use of replacement copy.
    - b. Painting, cleaning or other normal maintenance and repair of a sign not involving structural changes.
- B. MAINTENANCE / UNSAFE SIGNS - Every sign in the City shall be maintained in good structural condition. The Community Development Director may inspect and shall have the authority to order the painting, repair, alteration or removal of signs which become dilapidated or abandoned or which constitute a physical hazard to public safety. Any repair, painting, alteration, or removal will be at the sign owner's expense.
- C. LOCATION
1. All signs shall be on premise and may not extend beyond the property lines of the property on which the sign is located nor interfere with any public right-of-way or public easement, except as permitted specifically within this Ordinance or other City ordinances.
  2. No signs shall be erected in public right-of-way or on public sidewalks, except those necessary for regulatory, statutory or traffic control purposes, or other directional signs placed by the City of Foley, Baldwin County, the State of Alabama, or the United States.
- D. VISIBILITY
1. No sign shall be located so as to cause a public hazard, obstruct or impair motorists' vision, diminish safe ingress and egress to any property or impede flow of pedestrian or vehicular circulation in parking areas, sidewalks, or public roads.



2. Signs may not be located within the vision clearance areas, the triangular shaped areas located at the intersection of any combination of streets, alleys or driveways (as defined below). Nothing may be erected, placed, planted or allowed to grow in such a manner as to limit or obstruct the sight distance of motorists entering or leaving the intersection. The sides of the triangle extend from the intersection of the pavement or other vehicle travel areas.

a. Required Vision Clearance Area distances

Visibility Requirement by Street Classification				
A Distance in Feet	Street Type	B Distance in Feet		
		Driveway	Local Street	Collector/Arterial
25	Driveway	25	30	100
30	Local Street	25	30	100
100	Collector/Arterial	25	30	100

b. Vision Clearance Areas

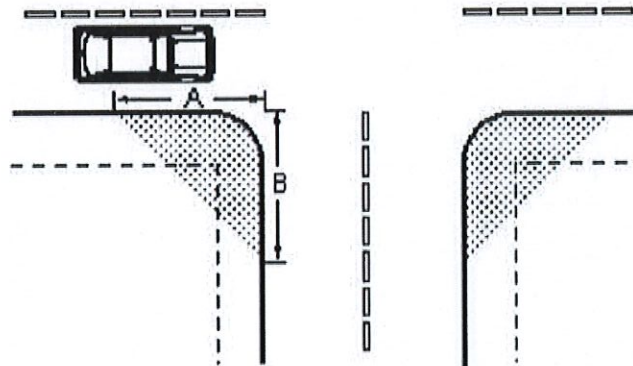

3. Signs must be located to provide unobstructed visibility and shall not be located between the heights of two and one-half (2 1/2) feet and ten (10) feet from grade within the Vision Clearance Areas. Structures and supports must have a combined total width of 12 inches or less and the combined total depth of 12 inches or less.

a. Vision Clearance Area

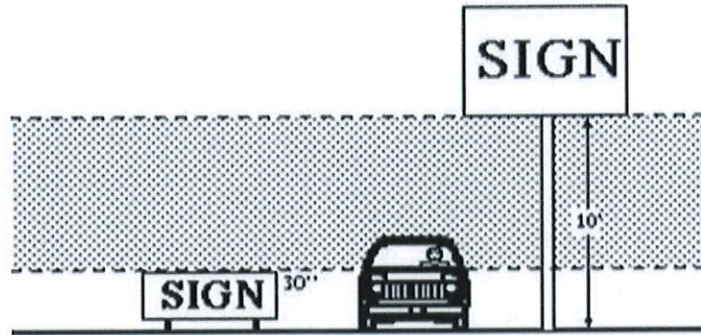

Height

E. MEASUREMENT AND CALCULATION STANDARDS

1. SIGN HEIGHT

- a. The height of a sign shall be computed as the distance from the base of the sign at normal grade (average grade at the base of the sign) to the top of the highest attached component of the sign.
- b. Normal grade shall be construed to be the newly established grade after construction, exclusive of any filling, berming, mounding, or excavating solely undertaken for the purpose of locating or increasing the height of sign.

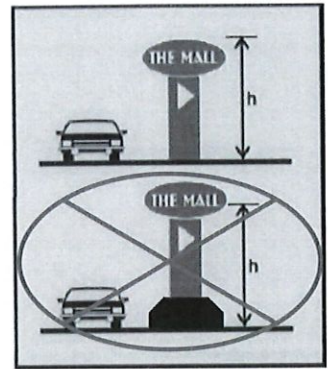

2. SIGN WIDTH

- a. The width of a sign shall be measured across the widest portion of a sign that runs parallel to the ground at the base of the sign.
- b. The sign width shall include all structure elements of a sign (e.g., support posts, sign cabinet, etc.).

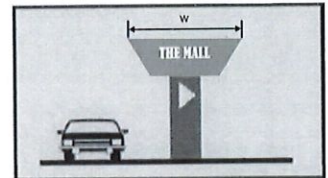

3. SIGN FACE AREA



- a. For sign copy mounted or painted on a background panel, cabinet, or surface distinctively painted, textured, lighted, or constructed to serve as the background for the sign copy, the sign area shall be computed by means of the smallest square, circle, rectangle, triangle, or combination thereof that

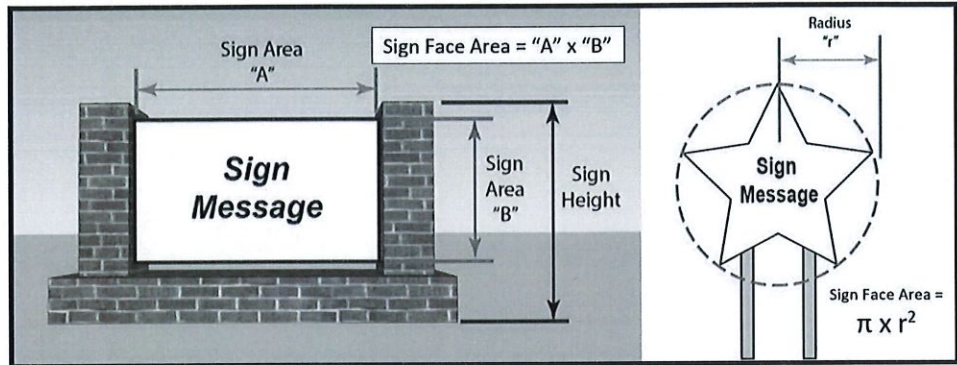

the extreme limits of the background panel, cabinet, or surface.

- b. For sign copy where individual letters or elements are mounted or painted on a building façade where there is no background panel, cabinet, or surface distinctively painted, textured, lighted, or constructed to serve as the background for the sign copy, the sign area shall be computed by means of the combination of the smallest square, circle, rectangle, triangle, or combination thereof that encloses all the letters or elements associated with the sign.

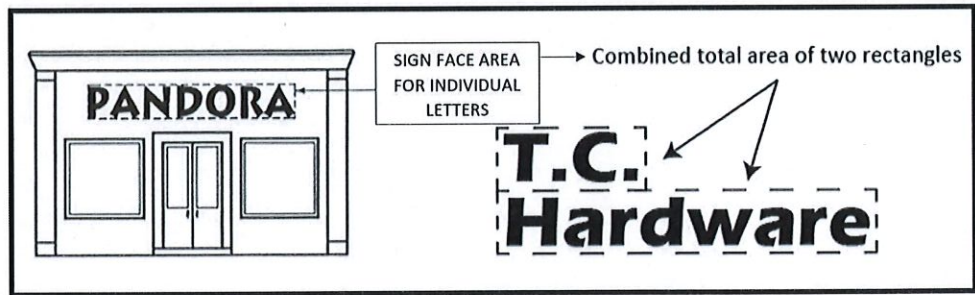

- c. The calculation of sign area shall not include any supporting framework, bracing, or decorative fence or wall unless such structural support is determined to constitute an integral part of the sign design by means of text or other commercial message, as determined by the Community Development Director.

#### F. SIGN TYPES

1. DETACHED SIGNS - Any sign supported by structures or supports that are placed on, or anchored in, the ground and that are independent from any building or other structure.
  - a. Monument Signs - A sign mounted to the ground and designed with a continuous structural element of approximately the same dimension from the ground to the top of the sign.

- b. Pole/Pylon Signs - Any sign supported by a pole, or poles, and otherwise separated from the ground by air.
- c. Multi-tenant Locator Signs - A single ground sign which identifies multiple businesses which are all tenants in a single structure, shopping center or complex. Must be located on the property that is being leased by the businesses who are displayed on the sign face unless otherwise allowed in this ordinance.
- d. Incidental/Directional Signs - A sign, generally informational, such as "no parking", "entrance", "exit", "loading only", "drive-through", "menu boards", and other similar directives. No sign with a commercial message legible from a position off the zoned lot on which the sign is located shall be considered incidental.

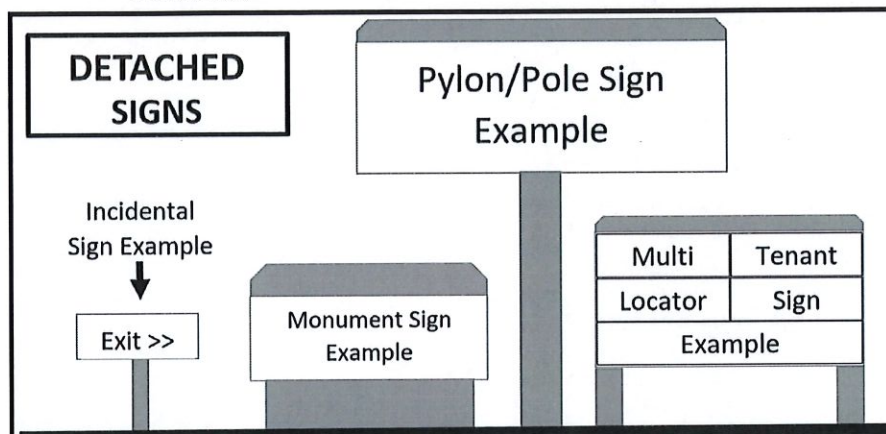

## 2. ATTACHED SIGNS

- a. Wall Signs - A sign entirely affixed directly to the wall of a building or the slope of a mansard-type roof, and/or projecting to a point less than twelve (12) inches beyond the wall surface.
- b. Suspended/Hanging Signs - A sign that is suspended from the underside of a horizontal plane surface and is supported by such a surface.
- c. Projecting Signs - Any sign affixed to any building or structure, extending beyond the building wall, structure, or building line by more than twelve (12) inches and no more than eighteen (18) inches. (For Local Downtown Historic District properties, refer to the Design Guidelines)
- d. Canopy/Awning Signs - Any sign that is a part of or attached to an awning, canopy, or other fabric, plastic, or structural protective cover over a door, entrance, window, or outdoor service area. A marquee is not a canopy.
- e. Marquee Signs - A projecting sign which is attached to or hung from a canopy, or a covered structure projecting from or supported by a building, extending beyond the building line.
- f. Mural Signs - A decoration or artwork painted on the exterior wall of a building which may be classified as a sign when it contains lettering, trade emblems or



logos. When such items are incorporated, the sign specifications shall be as follows:

1. Lettering- shall be localized and the area measured to conform to the size limitations of this Ordinance.
  2. Trade emblems and logos- the entire area of the mural shall be considered to be the sign face area and shall meet the size limitations contained in this Ordinance.
- g. Painted Wall Signs - A sign that is not a mural, but which is painted directly on the surface of a structure.
- h. Window Signs - Any sign, pictures, symbol, or combination thereof, designed to communicate information about an activity, business, commodity, event, sale or service, that is placed inside a window or upon the window panes or glass and is visible from the right-of-way.

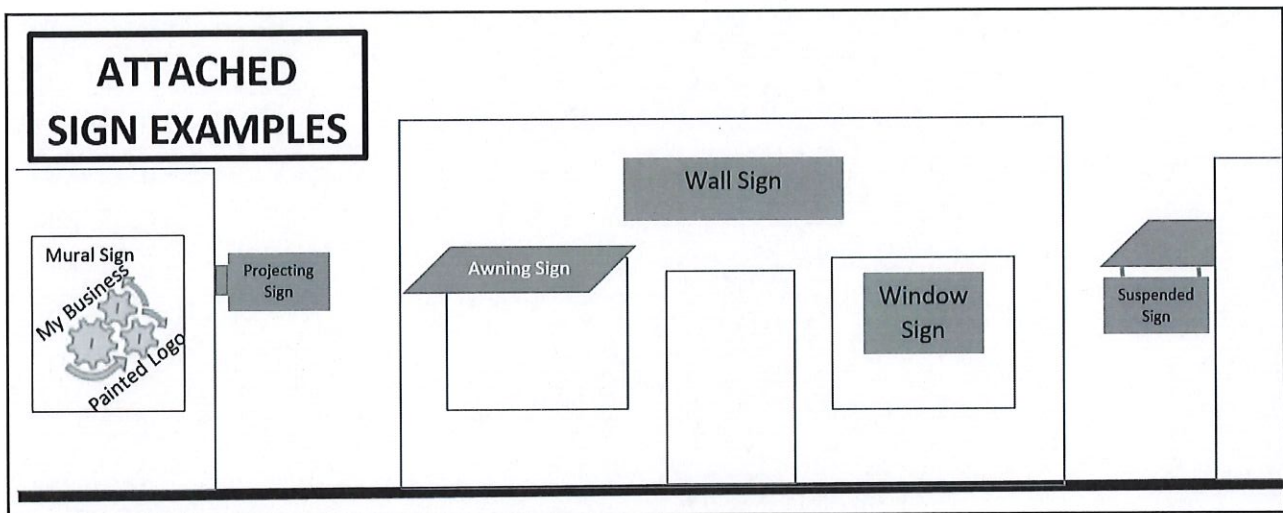

### 3. METHODS OF ILLUMINATION

- a. DIRECT - Light sources, including spotlights and neon tubing, which is attached to the sign face or structure and directed toward the copy area.
- b. INDIRECT - Light sources not attached to the sign structure or face area, but which are designed to be directed onto the sign face area.
- c. INTERNAL - Light sources enclosed in a sign face.
- d. ELECTRIC MESSAGE CENTER - Light sources arranged in rows, intended and designed to be individually and sequentially lit in such a manner to form letters and/or graphics which may blink on and off, travel, or flash. (See section 22.6 for further details and requirements.)

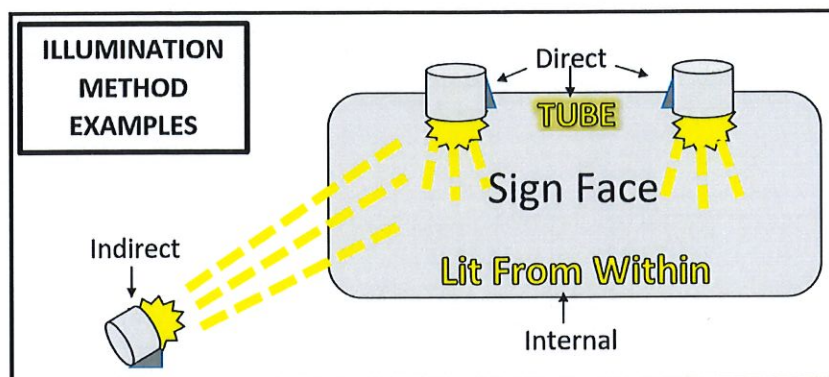

#### G. NON-CONFORMING SIGNS

1. SIGNS ELIGIBLE TO BE CONSIDERED "LEGAL NON-CONFORMING" - Any sign located within the city limits on the date of the adoption of this Ordinance or located in any area annexed to the City hereafter which does not conform to the provisions of this Ordinance, is eligible for characterization as a "Legal Non-Conforming" sign and is permitted, provided it meets the following requirements:
  - a. A permit had been issued for the construction of such sign prior to the date of the adoption of this Ordinance, if one was required under any other or prior city ordinance, or if no sign permit was required under any prior applicable City ordinances for the sign in question, the sign must have been in compliance with the prior applicable City ordinances as of the date of the adoption of this Ordinance.
  - b. If a sign was in compliance with all applicable regulations and laws prior to being annexed into the City of Foley, but is either prohibited or fails to conform with the Zoning Ordinance after annexation, then such sign may be considered a legal non-conforming sign.
2. LOSS OF LEGAL NON-CONFORMING STATUS - A legal non-conforming sign shall immediately lose its legal non-conforming status upon the occurrence of one or more of the events listed in this Zoning Ordinance, pursuant to state law, or when there is a change in:
  - a. The type of use or occupancy type on the property on which the sign is located;
  - b. The location, size, height, or type of sign; or
  - c. The amount of frontage such that the existing sign would not be permitted by this Ordinance.
  - d. A sign, being a structure, is also subject to the provisions of section 6.2.2 of this ordinance in regard to a prohibition of restoration after damage greater than 50% of its current replacement value.

#### 22.2 - PROHIBITED SIGNS



The following signs are prohibited in the City of Foley, and no permits for the construction of these signs will be issued, and all existing signs of this nature that are now in the corporate limits of the City of Foley or may hereafter come into the corporate limits of the City of Foley will either be classified as legal non-conforming or unlawful.

- A. Billboards, provided, however, the Planning Commission may, as part of its approval of the Master Signage Plan (MSP) for a PUD, PDD, or PID, grant one or more lots in the development the option to locate their ground sign(s) in specifically defined locations in a common area of that same PUD, PDD, or PID.
- B. Signs located in public areas or right-of-ways. With the exception of: Signs erected by or on behalf of the governmental entity responsible for maintenance and repair of said right-of-way, including signs posting legal notices, identifying public property, conveying public information, and signs directing or regulating pedestrian or vehicular traffic to businesses or other locations; bus stop signs erected by a public transit company; informational signs of a public utility regarding its poles, lines, pipes, or facilities; and awnings, projecting and suspended signs which conform to the conditions of these regulations.
- C. Vehicle Signs: except those vehicles used in normal day-to-day operations of the business. Vehicles parked for more than three (3) consecutive days are not considered regularly used in the conduct of normal day-to-day business. Vehicle signs used in normal day-to-day business shall be parked to the rear or side of businesses when possible. When rear and side parking is not possible vehicles shall be parked at a minimum of 100 feet from all highways and expressways. No vehicle signs shall be parked in the City right-of-way, unless the business has no other parking areas on premise.
- D. Portable Signs: A moveable sign that is not permanently attached to either the ground or a structure, or a sign designed to be transported, including, but not limited to, signs designed to be transported by means of wheels; sign converted to A- or T- frames; menu and sandwich board signs; feather flags; pennants; handheld signs; caricature signs; inflatable's; umbrellas (used for advertising), except those permitted as Special Event Signs in 22.4 EXEMPT PERMIT SIGNS or those which may be allowed in an applicable Overlay District.
- E. Roof top signs.
- F. Beacons and Revolving signs.
- G. Flashing signs, traveling lights or intensely lighted signs.

### **22.3 - TEMPORARY SIGNS NOT REQUIRING PERMITS**

The following temporary signs are allowed with the following conditions, and do not require a permit. This section specifically excludes Special Event Signs/Displays as described in 22.4 EXEMPT PERMIT SIGNS.

- A. Temporary signs shall not be illuminated.
- B. Drives or events of a civic, educational or religious nature are allowed to advertise for a period of two (2) weeks provided that:

1. The sign is non-electric.
  2. The sign face must be less than thirty-two (32) square feet.
  3. They may be located on and/or off premise, provided it is not in the public right-of-way nor causing a traffic hazard (see 22.1 D - Visibility).
- C. New businesses in the City are allowed to advertise with a single sign for a period of (2) weeks provided that:
1. The sign is non-electric.
  2. The sign face must not exceed thirty-two (32) square feet.
  3. The sign is located on premises and is not located in the public right-of-way nor causing a traffic hazard (see 22.1.D - Visibility).
- D. Real Estate Signs:
1. Real Estate "For Sale" or Rental Signs (Residential):
    - a. Two (2) signs per property advertising the sale or rental are allowed on-premise and two (2) signs are allowed off-premise.
    - b. Must not exceed four (4) square feet of copy area per sign.
    - c. Such signs shall not be permitted for a period longer than thirty (30) days after closing the sale or rental of the property.
  2. On-Premise Real Estate "For Sale" or "For Rent" Signs (Commercial):
    - a. One (1) real estate "For Sale" or "For Rent" sign for commercially zoned properties is allowed for properties with up to 500 linear feet of frontage. An additional sign is allowed for each additional 500 feet of frontage.
    - b. Must be located entirely within the property.
    - c. Must not exceed thirty-two (32) square feet of copy area per sign.
    - d. Such sign(s) shall be removed within thirty (30) days of closing the sale or rental of the property.
  3. Off-Premise Real Estate "For Sale" or "For Rent Signs (Commercial):
    - a. One (1) sign advertising the selling or rental of such property is permitted
    - b. Must not exceed four (4) square feet of copy area.
    - c. Such sign shall be removed within thirty (30) days of closing the sale or rental of the property.
  4. Construction Signs:
    - a. Must not exceed thirty-two (32) square feet of sign face.
    - b. May be placed no sooner than actual demolition or construction activities begin and may continue until the permanent sign is erected or the certificate of occupancy is issued, whichever comes sooner.
    - c. Such sign shall not be located in the public right-of-way nor cause a traffic hazard (see 22.1.D - Visibility).
  5. Model Homes:
    - a. Temporary A-frame signs shall be allowed in residential zones only to be located on the lot of the model home during the business hours in which an agent(s) is present.
- E. Campaign or Election Signs are exempt provided that:



1. Signs advocating or opposing a public office or a position on an issue to be determined at an election shall not exceed twelve (12) square feet in residential districts. In all other zoned districts, signs shall not exceed thirty-two (32) square feet.
2. Signs advocating or opposing a public office or position on an issue to be determined at an election shall be removed within ten (10) days after the election for which they were erected. In the event of a runoff election, signs may be displayed until the runoff election and then shall be removed within ten (10) days of the runoff election.
3. Property owners shall be held responsible for violations of campaign and election signs.
4. No signs shall be allowed in the public right-of-way, project into or overhang any right-of-way or be attached to any utility pole within the right-of-way.

F. Decorative Displays

1. Single balloons under twenty-four (24) inches in circumference that do not contain copy are considered decorative.
2. Flags that display seasonal, holiday, governmental and political displays are considered decorative.

**22.4 - TEMPORARY SIGNS REQUIRING AN EXEMPT PERMIT**

Temporary special use or event signs and displays are allowed but only under the following conditions and requirements:

- A. Special event signage and displays require an Exempt Permit (no fee required) found in the City's online permitting system under Planning & Zoning - Special Event Signs/Displays prior to the erection and placement of any such temporary sign or display. Such signs and displays shall be specifically described in writing as to their type and reason for special event.
  - a. Signs shall not exceed five (5) feet in height except for portable billboards.
  - b. Such signs shall not be illuminated.
  - c. For all lots containing multiple businesses, the property owner shall be responsible for all signage placed on the property, regardless of who erects the sign.
  - d. All such signs shall not be placed within ten (10) feet of the street right-of-way or in any other way as to obstruct the view of motorists or pedestrians.
  - e. An individual business shall be allowed a maximum of six (6) special event sign permits per calendar year, each of which shall be valid for four (4) consecutive days starting from the date of registration issuance or as noted on the registration.
- B. The following types of signs/displays which attract attention to a particular business may be registered as special event signs/displays:

SPECIAL EVENT SIGN / DISPLAY		
Sign Type	Quantity Allowed	Max Size Allowed

Balloons & Inflatables	1	20 ft in height from grade
Feather Flags	2	20 ft in height from grade
Pennants	2	???
Hand-held signs	1	6 sf sign face
Caricature signs	???	???
A or T frame signs	1	12 sf sign face
Menu/Sandwich Boards	1	12 sf sign face
Umbrellas	???	8 ft diameter
Banners	1	<del>12 sf</del> 30 sf sign face
Plastic/wire frame signs	1	12 sf sign face
Flags (not otherwise exempt)	1	15 sf
Portable Billboards	1	10'x13' or 130 sf

**22.5 - SIGNS REQUIRING A PERMIT**

A. PLANNED DISTRICT SIGNAGE - A Master Signage Plan (MSP) is designed to benefit the community in administering its sign regulations within a planned development and is required for the following zoning designations: Planned Unit Development (PUD), Planned Development District (PDD), and Planned Industrial District (PID). The Planning Commission will review the location, size, and other information to approve ground signs in common areas advertising specific businesses within a development. The Planning Commission may also review and approve any unique requests for other signage in these zones. The required information includes:

1. An accurate plot plan of the Development at a legible scale;
2. Location of signage for common areas, buildings, parking lots, driveways, amenities, landscaped areas and others;
3. An accurate indication of the proposed location of each present and future sign.
4. Size of the total Sign Face Area, the area of each individual sign, the height of the signs, an outline of the Sign Structure, and any electronic signage being requested.



5. A detailed description of any relaxation or exception that is being requested from the sizes shown in the following charts.
6. Documentation of who will be responsible for the maintenance and upkeep of the ground signs.

**B. RESIDENTIAL SIGNAGE**

1. The following Zones are considered “residential” for the purposes of these sign regulations: R-1R, R-1A, R-1B, R-1C, R-1D, R-2, R-3, R-4, GPH-1, TH-1, MH-1, RV Park, and residential areas of a PUD, PDD, or AO

RESIDENTIAL SIGNAGE ALLOWED								
Purpose	Sign Type	Max Area per Face	# Faces	Max Height	Illumination	Setback	Number Signs	Electronic allowed?
Primary Entrance Neighborhood Identification	Ground	50 sf	2	6 ft	Direct or Indirect		1 at Main entrance	no
Secondary Entrance Neighborhood Identification	Ground	32 sf	2	5-4 ft	Direct or Indirect	25 ft	1 per Secondary entrance	no
Home Occupation	Ground	4 sf	2	4 ft	PROHIBITED		1	no
Bed & Breakfast	Ground	4 sf	2	4 ft	Direct or Indirect		1 containing only name, street address, and occupancy info	no

**C. COMMERCIAL/INDUSTRIAL SIGNAGE**

1. The following Zones are considered “commercial/industrial use” for the purposes of these sign regulations: B-1, B-1A, B-2, B-3, M-1, Commercial & Industrial areas of a PUD or PDD
2. Painted Murals on the sides of buildings are allowed and are not considered to be a sign unless copy is included which advertises a business or service. If copy is included, this is a sign and must comply with this ordinance.
3. If a business does not have a ground sign, the wall sign may be increased by the square footage of the allowed ground sign.

4. Signs for free standing single tenant retail establishments in excess of 100,001 sf may increase by 10% for each additional 100,000 sf.
5. Based on street frontage, the total sign face area (wall & ground) as determined by following Commercial charts below may be increased as follows:

SIGN FACE AREA BY STREET FRONTAGE					
FRONTAGE	200-400 ft	401-600 ft	601-800 ft	801-1000 ft	>1000 ft
Increase to Sign Face Area	10%	20%	30%	40%	50%

6. The square footage of structures listed in the Purpose column of the chart below refers to the footprint of the ground foundation.

COMMERCIAL/INDUSTRIAL SIGNAGE ALLOWED (excluding B-1)							
Purpose	Sign Type	Max Area per Face	# Faces	Max Height	Illumination	Number Signs	Electronic allowed?
Free standing Single Tenant Structures  <2,900 sf	Wall	80 sf	1	not to exceed highest roofline	Internal	1 per Facing Street/ Driveway	Yes, except Historic.
	Ground	120 sf	2	20 ft	Internal	1 per 500 ft of frontage	Yes, except Historic.
Free standing Single Tenant Structures  2,901 - 15,000 sf	Wall	80 sf	1	not to exceed highest roofline	Internal	1 per Facing Street/ Driveway	Yes, except Historic.
	Ground	160 sf	2	25 ft	Internal	1 per 500 ft of frontage	Yes, except Historic.
Free standing Single Tenant Structures  15,001 - 30,000 sf	Wall	200 sf	1	not to exceed highest roofline	Internal	1 per Facing Street/ Driveway	Yes, except Historic.
	Ground	200 sf	2	25 ft	Internal	1 per 500 ft of frontage	Yes, except Historic.
Free standing Single Tenant Structures  30,001 - 50,000 sf	Wall	200 sf	1	not to exceed highest roofline	Internal	1 per Facing Street/ Driveway	Yes, except Historic.
	Ground	210 sf	2	25 ft	Internal	1 per 500 ft of frontage	Yes, except



							Historic.
Free standing Single Tenant Structures 50,001 - 100,000 sf	Wall	220 sf	1	not to exceed highest roofline	Internal	1 per Facing Street/ Driveway	Yes, except Historic.
	Ground	220 sf	2	30 ft	Internal	1 per 500 ft of frontage	Yes, except Historic.
Building Front signs for Establishments in Multi-tenant Buildings (only allowed if store has frontage)	Wall or Projecting	Not covering more than 30% of store frontage	W: 1 P: 2	not to exceed roofline	Internal	1 per Facing Street/ Driveway	Yes, except Historic.
Multi-tenant Locator Signs ≤ 10,000 sf	Ground	100 sf ***	2	25 ft	Internal	1	Yes, except Historic.
Multi-tenant Locator Signs 10,001 - 30,000 sf	Ground	150 sf ***	2	30 ft	Internal	1 per Facing Street, total sign face area of all locator signs not to exceed 200 sf	Yes, except Historic.
Multi-tenant Locator Signs ≥ 30,001 sf	Ground	300 sf ***	2	35 ft	Internal	1 per Facing Street, total sign face area of all locator signs not to exceed 400 sf	Yes, except Historic.
Parking Lot Identification	Ground	32 sf	2	5 ft	Non-oscillating, concealed light source. (spotlight or floodlight prohibited)	1 per entrance	No

B-1 COMMERCIAL SIGNAGE ALLOWED							
Purpose	Sign Type	Max Area per Face	# Faces	Max Height	Illumination	Number Signs	Electronic allowed?

Business Identification	Ground	32 sf	2	5 ft	Direct, Indirect, or Internal	1 per facing street	no
Business Identification	Wall or Projecting	40 sf max - may not exceed 30% of the buildings frontage	W: 1 P: 2	W: 20 ft, or at Roofline, whichever is lower P: Min 9 ft above sidewalk	Direct, Indirect, or Internal	1 per facing street / driveway	no
Multi tenant Business Identification	Wall or Projecting	2 sf	1	W: 20 ft, or at Roofline, whichever is lower P: Min 9 ft above sidewalk	n/a	1 per tenant at the entrance of each tenants space	no
Parking Lot Identification	Ground	32 sf	2	5 ft	Non- oscillating, concealed light source. (spotlight or floodlight prohibited)	1 per entrance	no

D. OFFICE SIGNAGE

- The following Zones are considered "office use" for the purposes of these sign regulations: PO, and Office areas of a PUD or PDD

OFFICE SIGNAGE ALLOWED							
Purpose	Sign Type	Max Area per Face	# Faces	Max Height	Illumination	Number Signs	Electronic allowed?
Office Buildings ≤ 10,000 sf floor area	Ground	32 sf	2	5 ft	Direct, Indirect, or Internal	1 per Facing Street	no
Office Buildings ≤ 10,000 sf floor area	Wall or Projecting	32 sf	W: 1 P: 2	12 ft	Direct, Indirect, or Internal	1 per Facing Street/Driveway	no



Office Buildings ≥ 10,001 sf floor area	Ground	50 sf	2	9 ft	Direct, Indirect, or Internal	1 per Facing Street	no
Office Buildings ≥ 10,001 sf floor area	Wall or Projecting	32 sf	W: 1 P: 2	20 ft, or at Roofline, whichever is lower	Direct, Indirect, or Internal	1 per Facing Street/Driveway	no
Parking Lot Identification	Ground	32 sf	2	5 ft	Non- oscillating, concealed light source. (spotlight or floodlight prohibited)	1 per entrance to parking lot	no

E. OTHER SIGNAGE

OTHER SIGNAGE ALLOWED									
Zone	Purpose	Sign Type	Max Area per Face	# Faces	Max Height	Illumination	Setback	Number Signs	Electronic allowed?
OA	Identification	Ground	200 sf	2	25 ft	Indirect / Internal	25 ft	1 per entrance	yes
Promotional/Sponsorship materials within Park boundaries are exempt from the Sign Regulations									

22.6 - ELECTRONIC SIGN REGULATIONS

Electronic changeable copy (ECC) signs may be permitted as a detached freestanding or attached flat sign as follows:

- A. Not allowed in the City of Foley Historic Overlay District, regardless of zone.
- B. Allowed in zones: B1A, Extended Business District; B2, Neighborhood Business District; B3, Local Business District; M1, Light Industrial District; and Open Space/Preservation District.
- C. Allowed in the commercial or industrial portions of a Planned Zone (PID, Planned Industrial District; PUD, Planned Unit Development; or PDD, Planned Development District), when specifically included as a part of a Master Signage Plan (see section 22.5.D.1).

- D. The signs must meet all size and Vision Clearance Area requirements for the zoning and/or overlay district in which they are located.
- E. May not display messages that do not pertain to business conducted on the premises on which the sign is located, unless otherwise exempted or a public service announcement.
- F. Display of any message must be static. There shall be no effects of movement, flashing, scintillation, or similar effects in the individual images.
- G. DETACHED FREESTANDING ELECTRONIC SIGN REQUIREMENTS

- a. The ECC sign must be located on the site of the use identified or advertised by the sign.
- b. No more than one (1) ECC sign with a maximum of two (2) parallel sides is permitted per lot of record.
- c. Lots with multiple businesses shall be allowed one (1) detached freestanding ECC sign to service all businesses located on that lot.
- d. ECC signs may not display colors, words, or images that interfere with or mimic a traffic control signal or device. (ie. - "STOP", "GO", "DANGER", etc.).
- e. Sign display technology shall be programmed so that the message or image on the sign changes ~~Electronic changeable copy signs shall change~~ no more than one (1) time per ten (10) seconds.
- f. Changes of image shall be substantially instantaneous as seen by the human eye and shall not use fading, rolling, window shading, flashing, spinning, rotating, dissolving, or similar effects as part of the change.
- g. Detached ~~electronic changeable copy~~ ECC signs must form an integrated portion of an on-premises detached sign. The electronic changeable copy portion of the detached sign may be separated from the remainder of the sign. If the electronic message center portion of the sign is being utilized after sunset, the existing static portion of the sign must be functioning, illuminated, and readable.
- h. The area of the ~~electronic changeable copy~~ ECC sign may comprise no more than fifty percent (50%) of the surface area of the allowable detached sign of which it is a part. Neither shall any portion of the ~~electronic changeable copy~~ ECC sign project above the height of the permanent detached signage. ~~Electronic changeable copy signs~~ ECC message centers are secondary to the permanent non-changeable portions of the sign and should be ~~designated~~ designed in this regard.
- i. An ~~electronic changeable copy~~ ECC sign shall be included in the calculation of the total permitted sign area of the detached sign of which it is a part.
- j. ~~The sign must have a light sensing/dimming device to control the maximum light intensity. The sign should be dimmed down 90% to a minimum 10% brightness at night.~~ Electronic changeable copy signs must have an automatic dimmer control to produce a distinct illumination change from a higher illumination level to a lower level (10% of max brightness) for the time period between one-half hour before sunset and one-half hour after sunrise. In addition, it must also be able to respond to lighting level changes occurring due to atmospheric conditions.
- k. ~~Electronic changeable copy signs located within any residential district are allowed only for neighborhood identification signs and bed and breakfasts, as permitted by special~~



~~exception.~~—The leading edge of an ~~electronic changeable copy~~ ECC sign located in any district must be a minimum distance of one hundred (100) feet from an abutting occupied single-family residential district boundary. An ~~electronic changeable copy~~ ECC sign may not face an abutting residential district.

- l. ~~Electronic changeable copy~~ ECC signs must be separated from other ~~electronic changeable copy~~ ECC signs by at least fifty (50) feet.
- m. All ~~electronic changeable copy~~ ECC signs will be maintained in proper working order.
  - i. If at any time the programming or technology that controls the brightness, time/date on message, or any other required visual display characteristic fails or malfunctions and is determined to be a hazard to the safety of the traveling public, the sign shall be immediately turned off, disconnected or disabled.
  - ii. Any dead zones or non-illuminated portions of the signs shall be replaced or repaired within fourteen (14) working days, or as soon as possible conditions allowing, or the use of the sign shall be discontinued.
- n. If at any time subsequent to the adoption of this Section of the Zoning Ordinance any portion of these regulations is deemed to be a safety hazard by the City of Foley, the City reserves the right to modify said regulations and all existing signs shall be modified to conform to the safety-related modifications.

#### H. ATTACHED FLAT ELECTRONIC SIGN REQUIREMENTS

- a. A maximum of one (1) single sided attached ECC wall sign is permitted for a site that does not contain any other ~~electronic changeable copy~~ ECC sign, detached or wall mounted.
- b. Such signs may not exceed thirty-two (32) square feet in area and will be counted toward the calculation for maximum signage for the building and must comply with all other applicable provisions of this ordinance.
- c. Wall mounted signs shall not be oriented toward adjacent residential uses.

## 22.7 - SIGNS LOCATED IN OVERLAY DISTRICTS

If a property is located within an overlay district, that Overlay District's specific signage rules and relaxations will override the rules stated within Article XXII in the event of a conflict.

## ARTICLE XI - SITE PLAN REVIEW

### 11.1 SITE PLAN REVIEW

Site plans may be required to be submitted to the Planning Commission for input in cases where the proposed development meets the following criteria. The site plan approval will be valid for 12 months but will expire after this date if no ~~building~~ permits have been obtained. The Planning Commission may ~~extend the site plan approval if it is determined there is an extenuating circumstance~~ **grant one 1-year extension if no city regulations have been amended that would affect the site.**

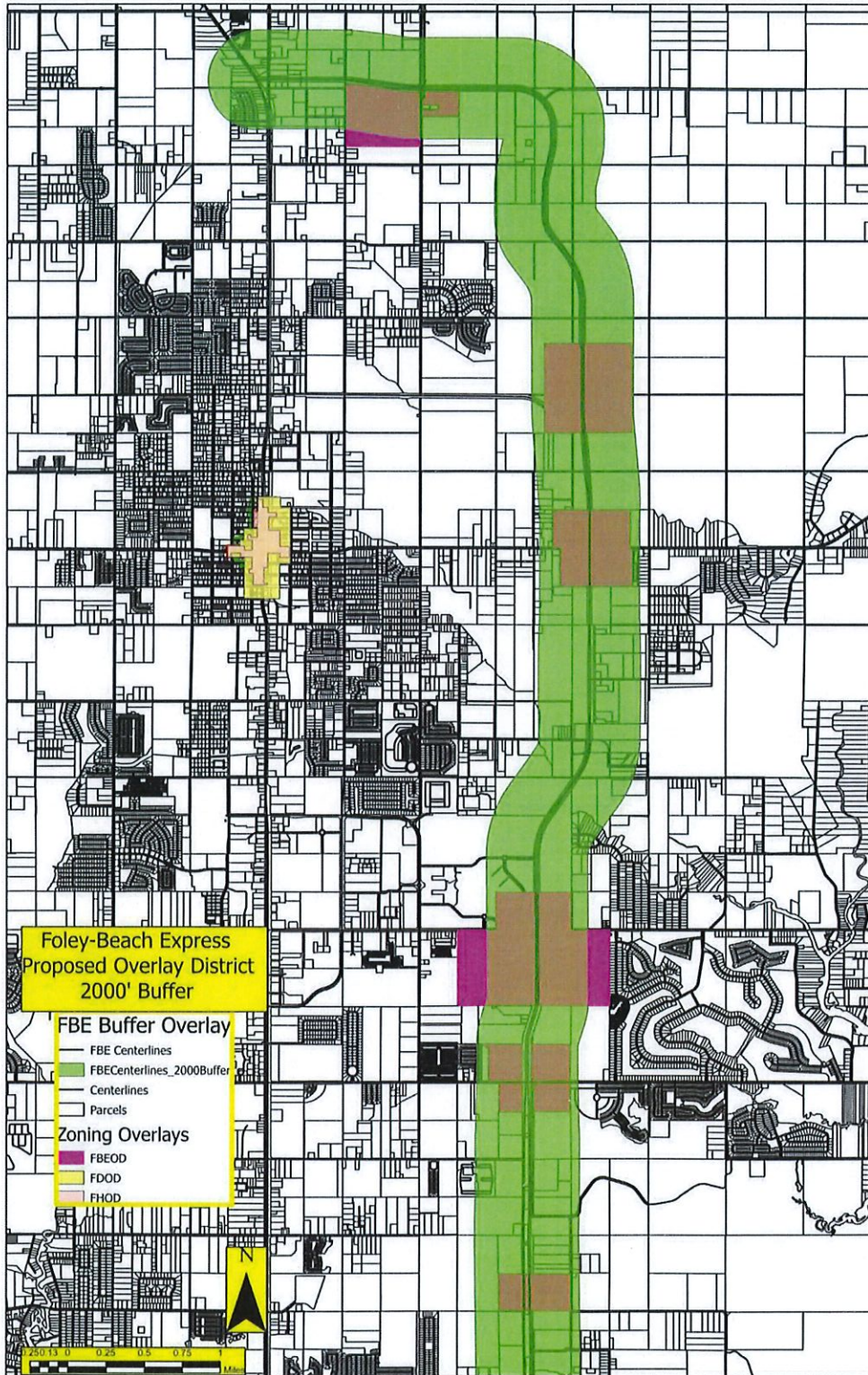

PASSED, ADOPTED AND APPROVED this day of